

# Intelligent Programmable Temperature Controller



### Features:

- Up to 16 segments of ramp/soak curve.
- The number and length of the curve can be set freely.
- The operations, such as pause, stop, repeat and so on, can be flexibly written into the program menu.
- Fast select the curve need to run.
- Support the PV start function.

### I. Model

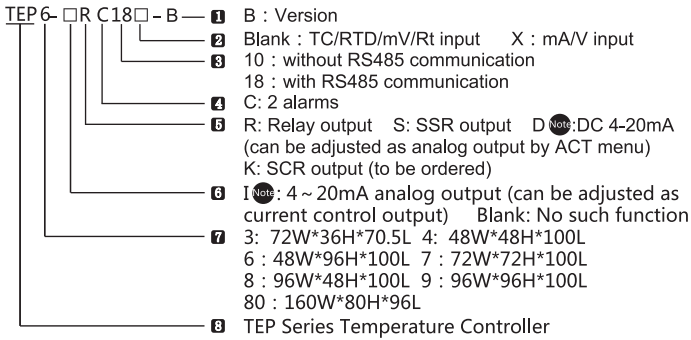

Please note the input signal type when you choose the model.  
1st type:TC/RTD/mV/Rt ; 2nd type: mA/V.

TEP series only have one 4~20mA output function. For size 6/8/9, when relay output/SSR output is together with DC 4~20mA, it is identified by "I", for example: IR, IS, etc, but there is no such model for size 3/4/7.

KKTEP-B01E-20220627

### III. Specifications

#### 1. Electrical parameters:

Sample rate	2 times per second
Relay capacity	AC 250V /3A Life of rated load>100,000 times
Power supply	AC/DC 100 ~ 240V ( 85-265V )
Power consumption	< 6VA
Environment	Indoor use only, temperature: 0~50□ no condensation, humidity < 85%RH, altitude<2000m
Storage environment	-10~60□, no condensation
SSR output	DC 24V pulse voltage, load<30mA
Current output	DC 4~20mA load<500Ω, temperature drift 250PPM
Communication port	RS485 port Modbus-RTU protocol, max input 30 units
Insulation impedance	Input, output, power VS meter cover > 20MΩ
ESD	IEC/EN61000-4-2 Contact ±4KV /Air ±8KV perf.Criteria B
Pulse triap anti-interference	IEC/EN61000-4-4 ±2KV perf.Criteria B
Surge immunity	IEC/EN61000-4-5 ±2KV perf.Criteria B
Voltage drop & short interruption immunity	IEC/EN61000-4-29 0% ~ 70% perf.Criteria B
isolation voltage	Signal input, output, power: 1500VAC 1min, <60V low voltage circuit: DC500V,1minn
Total weight	About 400g
Cover material	The shell and panel frame PC/ABS (Flame Class UL94V-0)
Panel material	PET(F150/F200)
Power failure memory	10 years, times of writing: 1 million times
Panel Protection level	IP65(IEC60529)
Safety Standard	IEC61010-1 Overvoltage category □ , pollution level 2 , level□ ( Enhanced insulation )

### II. Model

No.	Model	Main control output	Alarm No.	Analog output	RS485	Auxiliary power
1.	TEP3-DC18	SSR / 4~20mA	2	○	●	
2.	TEP3-DC10	SSR / 4~20mA	2	○		
3.	TEP3-RC18	RELAY	2		●	
4.	TEP3-RC10	RELAY	2			
5.	TEP4/7-DC18	4~20mA	2	○	●	●
6.	TEP4/7-DC10	4~20mA	2	○		●
7.	TEP4/7-SC18	SSR	2		●	
8.	TEP4/7-SC10	SSR	2			
9.	TEP4/7-RC18	RELAY	2		●	
10.	TEP4/7-RC10	RELAY	2			
11.	TEP6/8/9/80 -JSC18	SSR / 4~20mA	2	○	●	●
12.	TEP6/8/9/80 -JSC10	SSR / 4~20mA	2	○		●
13.	TEP6/8/9/80 -IRC18	RELAY / 4~20mA	2	○	●	●
14.	TEP6/8/9/80 -IRC10	RELAY / 4~20mA	2	○		●
15.	TEP6/8/9/80 -DC18	RELAY / 4~20mA	2	○	●	●
16.	TEP6/8/9/80 -DC10	RELAY / 4~20mA	2	○		●
17.	TEP6/8/9/80 -SC18	SSR	2		●	
18.	TEP6/8/9/80 -SC10	SSR	2			
19.	TEP6/8/9/80 -RC18	RELAY	2		●	
20.	TEP6/8/9/80 -RC10	RELAY	2			

"●" : The meter has this function.

"○" : The meter has this function, but it is combined with another function. This series only have one loop 4~20mA output, but the user can modify menu ACT to use it as main control output or analog output ( refer to menu illustration for details).

#### 2. Measured signal specifications :

Input type	Symbol	Measure range	Reso- lution	Accuracy	Input impedance /auxiliary current	Communication parameter code
K	Ƒ	-50~1200	1°C	0.5%F.S±3digits	> 500kΩ	0
J	Ƒ	0~1200	1°C	0.5%F.S±3digits	> 500kΩ	1
E	Ƒ	0~850	1°C	0.5%F.S±3digits	> 500kΩ	2
T	Ƒ	-50~400	1°C	0.5%F.S±2°C	> 500kΩ	3
B	Ƒ	250~1800	2°C	1%F.S±2°C	> 500kΩ	4
R	Ƒ	-10~1700	1°C	1%F.S±2°C	> 500kΩ	5
S	Ƒ	-10~1600	1°C	1%F.S±2°C	> 500kΩ	6
N	Ƒ	-50~1200	1°C	0.5%F.S±1°C	> 500kΩ	7
PT100	ƑƑ	-200~600	0.2°C	0.5%F.S±0.3°C	0.2mA	8
JPT100	ƑƑ	-200~500	0.2°C	0.5%F.S±0.3°C	0.2mA	9
CU50	ƑƑƑ	-50~150	0.2°C	0.5%F.S±3°C	0.2mA	10
CU100	ƑƑƑ	-50~150	0.2°C	0.5%F.S±1°C	0.2mA	11
0~50mV	ƑƑ	-1999~9999	12bit	0.5%F.S±3digits	> 500kΩ	12
0~400Ω	ƑƑ	-1999~9999	12bit	0.5%F.S±3digits	0.2mA	13
*4~20mA	ƑƑ	-1999~9999	12bit	0.5%F.S±3digits	100Ω	14
*0~10V	Ƒ	-1999~9999	12bit	0.5%F.S±3digits	>1MΩ	15

\*Pls indicate the requirement when choose the model.

#### 3. Isolation diagram

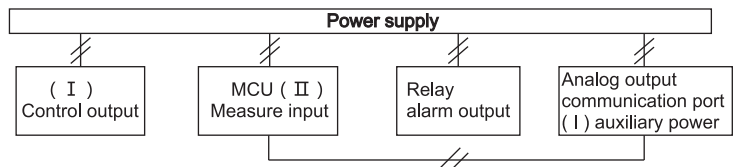

"// " : Isolation

Note : When the auxiliary power supply between ( I ) & ( II ) is used as the power supply for external sensor, if the sensor is non-isolated, it does not isolate.

## VI. Panel Illustration

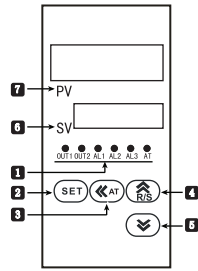

No.	Symbol	Name	Function
1	OUT1	OUT1 indicator light (red)*	Main control output indicator light, it is on when there is output.
	OUT2	OUT2 indicator light (red)*	Cooling output indicator light, it is on when there is output.
	AL1	Alarm1# indicator light (red)	1st alarm output indicator light, it is on when there is alarm output, it is off when there is no output.
	AL2	Alarm2# indicator light (red)	2nd alarm output indicator light, it is on when there is alarm output, it is off when there is no output.
	AL3	Alarm3# indicator light	AL3: this product does not have this function.
	AT	AT indicator light (green)	Auto tune indicator light, it is on when the meter is auto tuning.
2	SET	SET function key	Menu key/confirm key, to enter or exit the modification mode, or confirm and save the modified parameter.
3	⏪AT	Shift /AT key	Activate key/ shift key/ AT auto tune key (in measure and control mode, long press to enter/exit auto tune)
4	⏩R/S	Increase key/ R/S	Increase key, in measure and control mode, long press it to shift RUN/STOP mode, or check the menu in reverse order.
5	⏴	Decrease key	Decrease key, check the menu in sequence, long press to enter program menu.
6	SV	Display window (green)	Set value / parameter display window, the control is stopped when it displays "STOP" .
7	PV	Display window (red)	Measured value/ parameter code display window

\* : Size "3" light is green color.

4

## V. Dimension and installation size ( unit: mm)

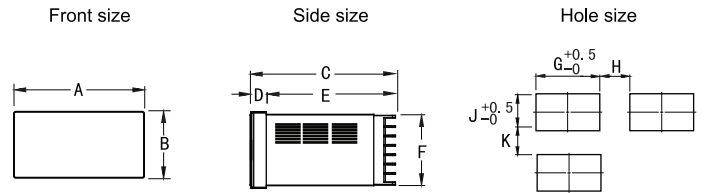

Model	A	B	C	D	E	F	G	H(Min)	J	K(Min)
3:(72*36)	72	36	70.5	6.5	64	32	68	25	33	25
4:(48*48)	48	48	97.5	6.5	91	45	45.5	25	45.5	25
6:(96*48)	48	96	97.5	9	88.5	89.5	45	25	92	25
7:(72*72)	72	72	97.5	9	88.5	67	67.5	25	67.5	25
8:(48*96)	96	48	97.5	9	88.5	44.5	92	25	45	25
9:(96*96)	96	96	97.5	9	88.5	91.5	92	25	92	25
80:(160*80)	160	80	96	13	83	75.5	155.5	30	76	30

5

## VI. Operation Process & Menu

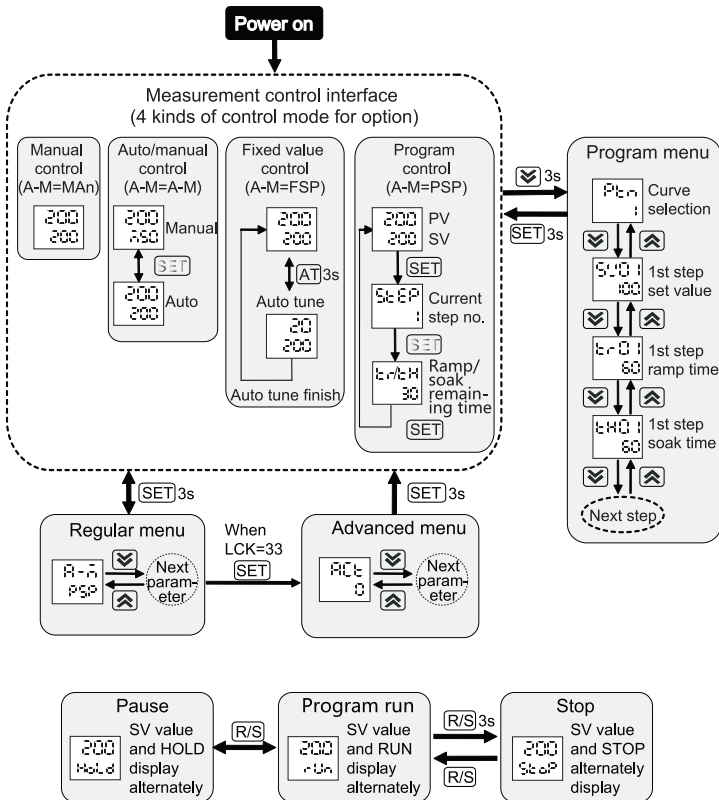

6

## Regular Menu

□ :Parameters will keep displaying all the time for all models and all control modes.  
 □ :Parameters will be hidden based on models and control modes.

No.	Symbol	Name	Illustration	Setting Range	Factory set
1	⏮-⏭	A-M	Auto/manual control mode	PSP: auto program control FSP: auto fixed value control MAN: manual control A-M: auto/manual control	PSP
2	⏮-⏭	POM	Running mode after power on, this parameter become effective only when A-M is set as PSP	PVSt: start from PV rSt: start from 1st step run: start from power failure HoLd: keep the temperature before power off StoP: stop running(ouput close)	rst
3	AL1	AL1	1st alarm set value	FL~FH	10
4	AL2	AL2	2nd alarm set value	FL~FH	5
5	HY1	HY1	1st alarm hysteresis value	0~1000	1
6	HY2	HY2	2nd alarm hysteresis value	0~1000	1
7	AD1	AD1	1st alarm mode, pls refer to alarm logic diagram (page13)	0~12	3
8	AD2	AD2	2nd alarm mode, pls refer to alarm logic diagram (page13)	0~6	4
9	PS	PS	Amend value	-1999~9999	0
10	INP	INP	Input signal type	Refer to signal table(page3)	K
11	OT	OT	Control mode 0: ON/OFF heating control 1: PID heating control 2: N/M 3: N/M 4: ON/OFF cooling control 5: PID cooling control	0~5	1
12	P	P	Proportional band, note: when the input type is switched between TC and RTD, the P value need to be modified manually. Eg.:when INP is changed from K to PT100, P=30 should be modified to P=300;when INP is changed from PT100 to K, P=300 should be modified to P=30.	1~9999	30
13	I	I	Integral time	0~9999	120
14	D	D	Differential time	0~9999	30
15	CP	CP	Control cycle, unit: second	1~200	20
16	DB	DB	On-off control hysteresis, note:when the input type is switched between TC and RTD, the processing mode is same as proportional band.	0~1000	5
17	LCK	LCK	Lock function. 0001:SV value can't be modified. 0010: menu setting value only can be checked, can't be modified. 0033: can enter to advanced menu. 0123: menus reset to factory setting.	0~9999	0

7

Advanced Menu

No.	Sym-bol	Name	Illustration	Setting Range	Factory set
18	ACT	ACT	Control output mode. 0:relay/SSR output. 1:SSR output(only for TEP3). 2: 4~20mA control output. Note: for TEP3, TEP4, TEP7, ACT set as 3, 4~20mA can be changed to analog output.	0~2 (0~3)	0
19	AE1	AE1	1st alarm extension, refer to table page 14.	0~5	0
20	AE2	AE2	2nd alarm extension, refer to table page 14.	0~5	0
21	DP	DP	Decimal point. TC has no decimal place, RTD has one decimal place, decimal place of linear signal can be set freely.	0~3	0
22	FT	FT	Filter coefficient, the higher of the value, the stronger of filter function.	0~255	10
23	DTR	DTR	PV fuzzy tracking value, it can get a stable control display value in some status. Note: when the alarm set value is near to SV value, may happen that the alarm value is not completely equal to display value (as the operation of alarm output is subject to actual measured value). Set it as 0 to close this function. Temperature unit °C/°F.	0.0~2.0 (0~20)	1.0 (10)
24	UT	UT	Temperature unit: °C/°F	°C/°F	°C
25	FL	FL	Measure range low limit, this parameter must be less than FL.	Refer to signal table	-50
26	FH	FH	Measure range high limit, this parameter must be greater than FH.	Refer to signal table	1200
27	BRL	BRL	Analog range low limit, when it is greater than BRH, the analog output is reserve analog.	FL~FH	-50
28	BRH	BRH	Analog range high limit, when it is less than BRL, the analog output is reserve analog.	FL~FH	1200
29	OLL	OLL	Control output low limit, this parameter must be less than OLH.	-5.0~100.0	0.0
30	OLH	OLH	Control output high limit, this parameter must be less than OLL.	0.0~105.0	100.0
31	SFO	SFO	Soft-start output limit, when PV is lower than SFT, this parameter will limit the meter control output power to its setting range.	0.0~100.0	100.0
32	SFT	SFT	Soft-start temperature threshold, when PV is lower than temperature SV of this parameter, it will limit the control output power.	-1999~9999	0
33	SMO	SMO	Curve turning point smoothing coefficient, if the temperature is overshoot because of short heating time and great heating amplitude of the temperature control curve, properly set this parameter to smooth the curve turning point, so as to decrease the temperature overshoot. Note: if TR(ramp remaining time)=0, but SV value still don't reach soak step temperature, it's normal.	0~100	0
34	GSK	GSK	Soak time temperature range, if the curve runs to soak step, only when PV value is within SV±GSK, the soak time will be counted, otherwise, it won't be counted.	0~9999	50

8

Continue

35	PDC	PDC	Control algorithm selection, FUZ: fuzzy algorithm STD: standard algorithm	FUZ/STD	FUZ
36	BAD	BAD	Communication baud rate	4.8K/9.6K	9.6K
37	ADD	ADD	Communication address	1~247	1
38	DTC	DTC	Communication delay time, for detailed explanation, refer to page 22	0~29	0
39	PRTY	PRTY	Check bit: NO: no check, EVEN: even parity check odd: odd parity check	NO/EVEN/odd	NO
40	CAE	CAE	User self-calibration function, used for the calibration of non-temperature signal. YES: enable. NO: use factory set.	YES/NO	NO
41	CAL	CAL	User self-calibrate low limit input. Input a low-limit signal to the signal terminal and flash YES to activate the calibration, after the confirmation it will display OK, then the signal low limit calibration is finished.	YES/OK	YES
42	CAH	CAH	User self-calibrate high limit input. Input a high-limit signal to the signal terminal and flash YES to activate the calibration, after the confirmation it will display OK, then the signal high limit calibration is finished.	YES/OK	YES
43	VER	VER	Software version	--	--

Program menu

No.	Sym-bol	Name	Illustration	Setting Range	Factory set
44	PTN	PTN	Temperature control curve selection, for example, in the whole program menu, there are three THxx set as STOP or RPT, so the curve total no. is 3, and the setting range of PTN is 1~3.	1~ curve total no.	1
45	SV01	SV01	1st step set value	FL~FH	0
46	TR01	TR01	1st step ramp time (minute)	0~9999	0
47	TH01	TH01	1st step soak time (minute). HoLd: the curve pauses. StoP: the curve stops. RPT: the curve repeats.	0~9999, HoLd/StoP/RPT	0
2nd ~ 15th steps same as above					
48	SV16	SV16	16th step set value	FL~FH	0
49	TR16	TR16	16th step ramp time (minute)	0~9999	0
50	TH16	TH16	16th step end method	StoP/RPT	StoP

9

VII. Programming

When THxx=STOP or RPT, it means the end point of a curve. The next step of the last curve's end point is the starting point of the next curve. STOP means that at this point the curve will stop running and output shut-down, RPT means that at this point the curve will repeat again from the starting point of the curve. When THxx=HOLD, it means the curve will automatically enter the pause mode (soak and stop counting time), but it is not taken as the end point of the curve.

PTN	SV01	SV02	SV03	SV04	SV05	SV06	SV07	SV08	SV09	SV10	SV11	SV12	SV13	SV14	SV15	SV16
3	100	200	100	25	100	200	800	1000	200	50	100	200	500	1000	900	100
	TR01	TR02	TR03	TR04	TR05	TR06	TR07	TR08	TR09	TR10	TR11	TR12	TR13	TR14	TR15	TR16
	30	20	20	30	30	20	40	30	50	40	30	30	100	30	30	30
	TH01	TH02	TH03	TH04	TH05	TH06	TH07	TH08	TH09	TH10	TH11	TH12	TH13	TH14	TH15	TH16
	40	60	40	STOP	40	60	100	100	100	RPT	60	90	HOLD	60	60	RPT

In this program table, there are 3 THxx set as STOP or RPT, TH04=STOP, TH10=RPT, TH16=RPT. The program automatically generates 3 curves. The starting point and end point of each curve are respectively as follows:  
 Curve 1: run from 1st step to 4th step, and stop running.  
 Curve 2: run from 5th step to 10th step, and repeat.  
 Curve 3: run from 11th step to 16th step, and repeat.  
 PTN=3 means choosing curve 3 as running curve.  
 Note: after the setting of the program menu, under the control interface, need to reset once (keep pressing R/S key until it displays STOP, and then click R/S key again to activate).

- Process curve (starting temperature 25°C )
1. Choose curve 1 (the program starts from 1st step to 4th and stop). PTN=1;
  2. STEP1: use 30 minutes to raise the temperature to 100°C and hold it for 40 minutes. SV01=100, TR01=30, TH01=40 ;
  3. STEP2: use 20 minutes to raise the temperature to 200°C and hold it for 60 minutes. SV02=200, TR02=20, TH02=60 ;
  4. STEP3: use 20 minutes to lower the temperature to 100°C and hold it for 40 minutes. SV03=100, TR03=20, TH03=40 ;
  5. STEP4: use 30 minutes to lower the temperature to 25°C and stop running. SV04=25, TR04=30, TH04=STOP ;

10

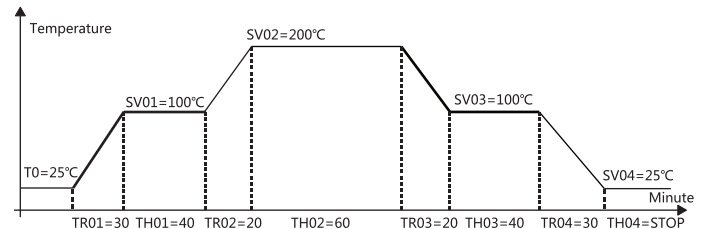

Note: cooling rate of the curve can't be faster than the natural cooling rate of the controlled object.

VIII. Important function operation

① Auto tune

Operation steps:

- ① Set Paramtere A-M as FSP to enter fixed value control.
- ② Make sure PV value < 1/2 SV value.
- ③ Keep pressing AT key to make AT light turn on.
- ④ The system will automatically enter into auto tune, curve as shown on the left.
- ⑤ AT light turns off, auto tune finishes, the meter will automatically enter PID control.
- ⑥ Set parameter A-M as PSP to resume program control.

11

②Pause • run

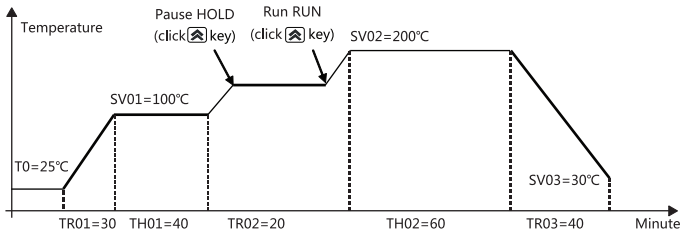

③Stop • run

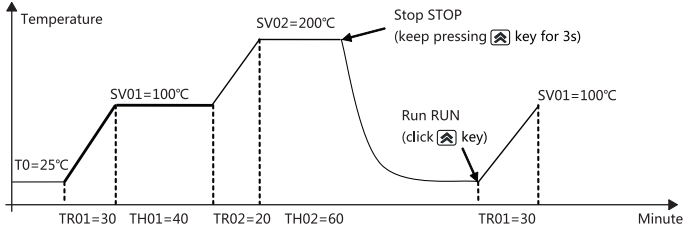

④Measured value start-up

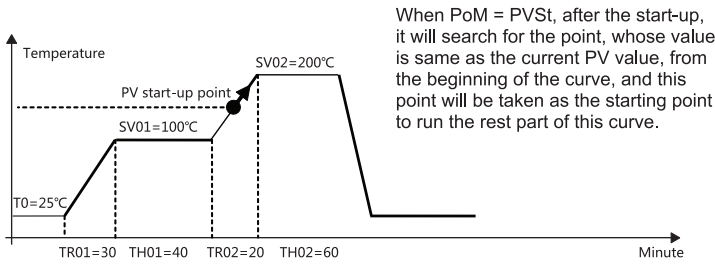

IX. Alarm Function

( 1 ) Alarm parameter and output logic diagram:

Symbol description: “☆” means HY, “▲” means alarm value, “△” means SV value

No.	Type	Alarm output(AL1,AL2 is independent of each other) Image: the hatched section means the alarm action.
1	High limit absolute value alarm	
2	Low limit absolute value alarm	
3	※High limit deviation value alarm	
4	※Low limit deviation value alarm	
5	※High/low limit deviation value alarm	
6	※High/low limit interval value alarm	

No.	Type	The following two group of alarm parameters(AL1、AL2) used in combination,AL1 alarm output , AD2 must be set as 0
7	High/low limit absolute value alarm	
8	※High/low limit deviation value alarm	
9	※Alarm between high limit absolute value and low limit deviation value .	
10	※Alarm between high limit deviation value and low limit absolute value.	
11	High/low absolute value alarm	
12	※High/low limit deviation alarm	

※When the alarm value with deviation alarm set as a negative number, it will deal with it as an absolute value.

( 2 ) Alarm extension function table

AE1/AE2 value	Alarm handling mode when it displays HHHH/LLLL	Alarm handling mode when power on
0	Alarm status remain unchanged	Power on alarm non-restraining (As long as it meets the alarm condition, alarm output immediately)
1	Force alarm output	
2	Force alarm close	Power on alarm restraining ( After power on, before the PV value reach the SV value for the first time, force alarm close, after that alarm work normally)
3	Alarm status remain unchanged	
4	Force alarm output	
5	Force alarm close	

X. Connections

TEP3

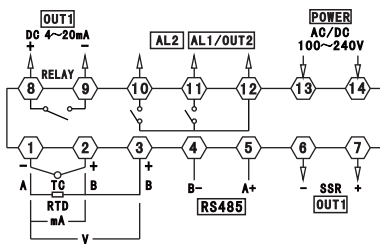

TEP4

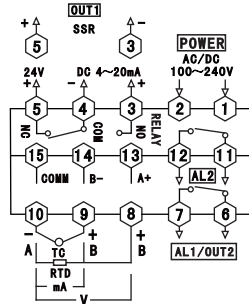

TEP80

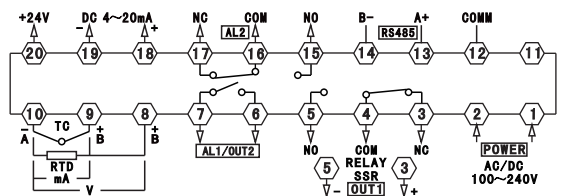

Note: If there is any change, please subject to the drawing on the meter.

TEP7

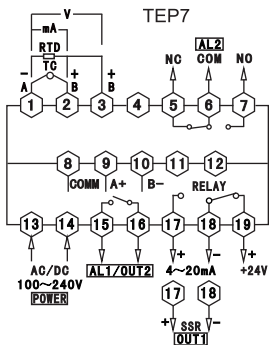

TEP6

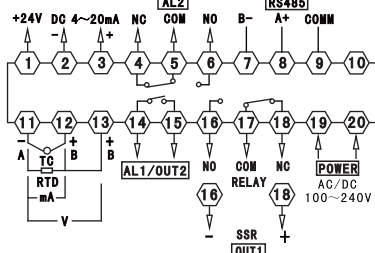



## XI. Checking methods of simple fault

Display	Checking methods
LLLL/HHHH	Checks whether the input disconnection and whether normal of FH value, FL value, working environment temperature and whether input signal is selected correctly.

## XII. Communication protocol

Meter adopts RS485 Modbus RTU communication protocol, RS485 half duplex communication. Read function code 0x03, write function code 0x10/0x06. Adopt 16 digit CRC check, the meter does not return for error check. Data type adopts short, data transmission order is that high bit in front, low bit behind, pls check the example for details.

Data frame format:

Start bit	Data bit	Stop bit	Check bit
1	8	1	No

Abnormal communication processing :

When abnormal response , put 1 on the highest bit of function code. For example: Host request function code 0x03, and slave response function code should be 0x83.

Error code:

0x01—Illegal function: the function code sent from host is not supported by meter.  
 0x02—Illegal address: the register address designated by host beyond the address range of meter.  
 0x03—Illegal data: Data value sent from host exceeds the corresponding data range of meter.

Communication cycle :

Communication cycle is the time from host request to slave response data.  
 ie: communication cycle= time of request data sending +slave preparation time + response delay time + response return time. Eg:9600 Baud rate:communication cycle of single measured data ≥250ms.

16

Slave normal answer (write multi-register)							
1	2	3	4	5	6	7	8
Meter ADD	Function code	Start ADD High bit	Start ADD Low bit	Data byte length high bit	Data byte length low bit	※CRC code low bit	※CRC code high bit
0x01	0x10	0x20	0x03	0x00	0x01	0xFA	0x09

### 3、Write single-register

For example: Host use 0x06 function code write SV (setting value 150)

Host request ( write single-register)							
1	2	3	4	5	6	7	8
Meter ADD	Function code	ADD High bit	ADD Low bit	Data high bit	Data low bit	※CRC code low bit	※CRC code high bit
0x01	0x06	0x20	0x03	0x00	0x96	0xF2	0x64

Slave normal answer(write single-register )							
1	2	3	4	5	6	7	8
Meter ADD	Function code	ADD High bit	ADD Low bit	Data high bit	Data low bit	※CRC code low bit	※CRC code high bit
0x01	0x06	0x20	0x03	0x00	0x96	0xF2	0x64

Slave abnormal answer(write single-register )				
1	2	3	4	5
Meter ADD	Function code	Error code	※CRC code low bit	※CRC code high bit
0x01	0x86	0x02	0xC3	0xA1

18

### 1、Read register

For example:Host reads integer SV(set value 200 )

The address code of SV is 0x2003, because SV is integer(2 dyte), seizes 1 data register. The memory code of decimal integer 200 is 0x00C8.

Note:It should read DP value or confirm DP menu value first to ensure the decimal point position when reading data, and converse the reading data to get the actual value. On the contrary ,it should converse the data to corresponding ratio first before writing the data into meter.

Host request ( Read multi-register )							
1	2	3	4	5	6	7	8
Meter ADD	Function code	Start ADD High bit	Start ADD Low bit	Data byte length high bit	Data byte length low bit	※CRC code low bit	※CRC code high bit
0x01	0x03	0x20	0x03	0x00	0x01	0x7F	0xCA

Slave normal answer(Read multi-register )						
1	2	3	4	5	6	7
Meter ADD	Function code	Data byte number	Data high bit	Data low bit	※CRC code low bit	※CRC code high bit
0x01	0x03	0x02	0x00	0xC8	0xB9	0xD2

slave abnormal answer(Read multi-register)				
1	2	3	4	5
Meter ADD	Function code	Error code	※CRC code low bit	※CRC code high bit
0x01	0x83	0x02	0xC0	0xF1

### 2、Write multi-register

For example:Host use 0x10 function code write SV ( setting value 150 )ADD code of SV is 0x2000, because SV is integer(2 dyte), seizes 1 data register. The hexadecimal code of 150 is 0x0096.

Host request ( write multi-register )										
1	2	3	4	5	6	7	8	9	10	11
Meter ADD	Function code	Start ADD High bit	Start ADD Low bit	Data byte length high bit	Data byte length low bit	Data byte length	Data high bit	Data low bit	※CRC code low bit	※CRC code high bit
0x01	0x10	0x20	0x03	0x00	0x01	0x02	0x00	0x96	0x07	0xCF

17

### Parameters reflection address

No.	Add reflection	Name	Illustration	Read /write	Remark
1	0x2000	PV	Measured value	R	In concert with DP value to read data
2	0x2001	STA	Output state	R	Refer to note①
3	0x2002	MV	Output	R/W	
4	0x2003	SV	Set value	R/W	When it is program control, the read SV is the set value of the current program; the written SV is the set value of fixed value control.
5	0x2004	RSA	Running state setting	R/W	Run(0) ; stop(2) ; pause(1) ; auto tune(3) ;
6	0x2005	A-M	Auto/manual mode	R/W	Program control(-1) ; Fixed value control(0) ; Manual control(1) ; Manual/ auto key switch(2) ;
7	0x2006	STEP	Current step no. of the curve	R	
8	0x2007	TR	Ramp remaining time	R	
9	0x2008	TH	Soak remaining time	R	
Reserve					
10	0x2010	INP	Signal type	R/W	
11	0x2011	FL	Range low limit	R/W	In concert with DP value to read data
12	0x2012	FH	Range high limit	R/W	In concert with DP value to read data
13	0x2013	DP	Decimal point	R/W	
14	0x2014	UT	Unit of temperature	R/W	°C(25)/°F(26)
15	0x2015	PS	Amend value	R/W	
16	0x2016	FT	Filter coefficient	R/W	
17	0x2017	DTR	PV fuzzy tracking value	R/W	0.0~2.0(0~20)
Reserve					
18	0x2020	AL1	1st alarm set value	R/W	
19	0x2021	AL2	2nd alarm set value	R/W	Pay attention to add jump
20	0x2024	HY1	1st alarm hysteresis, value	R/W	
21	0x2025	HY2	2nd alarm hysteresis, value	R/W	Pay attention to add jump

19

Reserve					
22	0x2028	AD1	1st alarm mode	R/W	
23	0x2029	AD2	2nd alarm mode	R/W	Pay attention to add jump
24	0x202C	AE1	1st alarm extended function	R/W	
25	0x202D	AE2	2nd alarm extended function	R/W	
Reserve					
26	0x2040	POM	Running mode after power on	R/W	PVST(-2); RST(-1); RUN(0); HOLD(1); STOP(2);
27	0x2041	OT	Control mode	R/W	
28	0x2042	ACT	Control output mode	R/W	
29	0x2043	PDC	PID algorithm	R/W	0 : Fuz; 1 : Std
30	0x2045	P	Proportional coefficient	R/W	
31	0x2046	I	Integral time	R/W	
32	0x2047	D	Differential time	R/W	
33	0x2048	CP	Control cycle	R/W	
34	0x2049	DB	On-off control hysteresis	R/W	
35	0x204A	OLL	Control output low limit	R/W	Default with 1 decimal place
36	0x204B	OLH	Control output high limit	R/W	Default with 1 decimal place
37	0x204D	BRL	Analog range low limit	R/W	In concert with DP value to read data
38	0x204E	BRH	Analog range high limit	R/W	In concert with DP value to read data
39	0x2052	SFO	Soft-start output limit	R/W	
40	0x2053	SFT	Soft-start temperature threshold	R/W	
41	0x2054	SMO	Curve turning point smoothing coefficient	R/W	
42	0x2055	GSK	Soak time temperature range	R/W	
Reserve					
43	0x2060	PTN	Temperature control curve selection	R/W	Pay attention to add jump
44	0x2062	SV01	1st step set value	R/W	
45	0x2063	TR01	1st step ramp time	R/W	
46	0x2064	TH01	1st step soak time	R/W	-1:HOLD;-2:STOP; -3:RPT
47	0x2065	SV02	2nd step set value	R/W	
48	0x2066	TR02	2nd step ramp time	R/W	
49	0x2067	TH02	2nd step soak time	R/W	Function similar to TH01

20

50	0x2068	SV03	3rd step set value	R/W	
51	0x2069	TR03	3rd step ramp time	R/W	
52	0x206A	TH03	3rd step soak time	R/W	Function similar to TH01
53	0x206B	SV04	4th step set value	R/W	
54	0x206C	TR04	4th step ramp time	R/W	
55	0x206D	TH04	4th step soak time	R/W	Function similar to TH01
56	0x206E	SV05	5th step set value	R/W	
57	0x206F	TR05	5th step ramp time	R/W	
58	0x2070	TH05	5th step soak time	R/W	Function similar to TH01
59	0x2071	SV06	6th step set value	R/W	
60	0x2072	TR06	6th step ramp time	R/W	
61	0x2073	TH06	6th step soak time	R/W	Function similar to TH01
62	0x2074	SV07	7th step set value	R/W	
63	0x2075	TR07	7th step ramp time	R/W	
64	0x2076	TH07	7th step soak time	R/W	Function similar to TH01
65	0x2077	SV08	8th step set value	R/W	
66	0x2078	TR08	8th step ramp time	R/W	
67	0x2079	TH08	8th step soak time	R/W	Function similar to TH01
68	0x207A	SV09	9th step set value	R/W	
69	0x207B	TR09	9th step ramp time	R/W	
70	0x207C	TH09	9th step soak time	R/W	Function similar to TH01
71	0x207D	SV10	10th step set value	R/W	
72	0x207E	TR10	10th step ramp time	R/W	
73	0x207F	TH10	10th step soak time	R/W	Function similar to TH01
74	0x2080	SV11	11th step set value	R/W	
75	0x2081	TR11	11th step ramp time	R/W	
76	0x2082	TH11	11th step soak time	R/W	Function similar to TH01
77	0x2083	SV12	12th step set value	R/W	
78	0x2084	TR12	12th step ramp time	R/W	
79	0x2085	TH12	12th step soak time	R/W	Function similar to TH01
80	0x2086	SV13	13th step set value	R/W	

21

81	0x2087	TR13	13th step ramp time	R/W	
82	0x2088	TH13	13th step soak time	R/W	Function similar to TH01
83	0x2089	SV14	14th step set value	R/W	
84	0x208A	TR14	14th step ramp time	R/W	
85	0x208B	TH14	14th step soak time	R/W	Function similar to TH01
86	0x208C	SV15	15th step set value	R/W	
87	0x208D	TR15	15th step ramp time	R/W	
88	0x208E	TH15	15th step soak time	R/W	Function similar to TH01
89	0x208F	SV16	16th step set value	R/W	
90	0x2090	TR16	16th step ramp time	R/W	
91	0x2091	TH16	16th step soak time	R/W	-2:STOP; -3:RPT
Reserve					
92	0x2FF0	ADD	Communication add	R/W	
93	0x2FF1	BAD	Baud rate	R/W	0 : 4.8K ; 1 : 9.6K
94	0x2FF2	DTC	Communication delay time	R/W	Refer to note②
95	0x2FF3	PRTY	Parity Check	R/W	0: no; 1: even parity; 2: odd Parity
96	0x2FF4	LCK	Lock	R	
97	0x2FF5	VER	Version	R	

R : read only ; R/W: read/write.

Note① : measuring state indication, when data bit=1, it means output; when data bit=0, it means no output.

D7	D6	D5	D4	D3	D2	D1	D0
STOP	HHHH	LLLL	AT	AL2	AL1	OUT2	OUT1

Note②: Sequenced transport and response delay of DTC communication data

DTC : □ □ □ — Response delay: 0 ~ 9 means 10 ~ 100ms  
 — Sequenced transport of byte: 0: high byte in front, low byte behind;  
 — Reserve 1: low byte in front, high byte behind

```

※16 digits CRC check code get C program
unsigned int Get_CRC(uchar *pBuf, uchar num)
{
    unsigned ij;
    unsigned int wCrc = 0xFFFF;
    for(i=0; i<num; i++)
    {
        wCrc ^= (unsigned int)(pBuf[i]);
        for(j=0; j<8; j++)
        {
            if((wCrc & 1) && (wCrc >>= 1); wCrc ^= 0xA001; }
            else wCrc >>= 1;
        }
    }
    return wCrc;
}

```

22

23