

DR9 Series 3 Phase Multi-function Power Recorder



This meter can measure and record the true value of voltage , ampere , active power , reactive power , power factor , Kwh , KvarH ect. It also can generates all kinds of forms . The parameters historical records can be passed to PC to store or analysis through USB connection and SD card. With RS485 communication port and RS232 modbus RTU. It can be widely used in SCADA system and energy management system , power station automation system , power grid , estate power monitor , industrial automation system , intelligent building , intelligent switchboard , switch cabinet.

Features:

- ⊙ 320*340 TFT color LCD display.
- ⊙ Measure 3 phase voltage , ampere , reactive power ,active power , apparent power , power factor , frequency , Kwh , KvarH ect.
- ⊙ Three phase voltage , ampere , active power , reactive power , frequency , and other parameters real time record and curve record storage.
- ⊙ Total active power value and total reactive power value accumulation memory function.
- ⊙ 8M flash memory inner side of the meter for data storage , support SD card and USB storage , maximum storage is 1GB. The datasheet of the recorder can copy to the SD card automatically .
- ⊙ Switch output: 2 loop AL1, AL2 relay switch output , 250V AC/3A or 30V DC/5A.
- ⊙ Analog output : 1 loop analog 4-20mA DC output.
- ⊙ Switch input : 2 loop S1-S2 , used in remote control the electric swith status.
- ⊙ With RS485 communication , Modbus RTU.
- ⊙ Meter can connect with panel Mini-printer , print the historical data by manual and print the real time data and power forms automatically .
- ⊙ Backup data can be opened by PC software to show the real time curve record.

■ Model Illustration

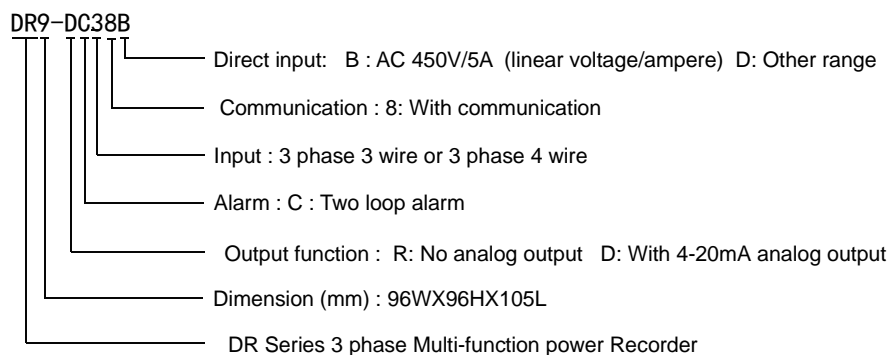

■ Model

Model	Input range	Communication	Analog output	switch output	Alarm output
DR9-DC38B	AC 50V~450V linear voltage	RS485	4~20mA	2 loop	2 loop
DR9-RC38B	AC 0.025A~5A linear ampere		No		

■ Panel Indication

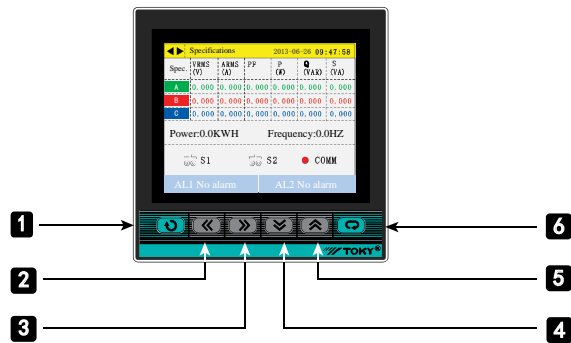

No	Symbol	Name	Function
1		Set Key	In configuration setting , choose the menu and data to be modified , Confirm and storage the modification before exit the menu.
2		Left Shit Key , Page Left Key	Left shift key : When modifying the menu parameters , push the shift key to left to choose the parameter to be modified.
3		Right Shit Key , Page Right Key	Right shift key: when modifying the menu parameters , can move the shift key to right to choose the parameter to be modified.
4		Decrease Key	Decrease the setting value of parameter when modifying parameters.
5		Increase Key	Increase the parameter value when modifying the parameters.
6		Page Shift Key , Return Key	Page shift key : In normal running status shift the pages in same display mode. Return : In normal menu setting status , used to return the previous menu.

■ Technical Parameters

Connection	3 phase 3 wire , 3 phase 4 wire
Rated voltage	Linear voltage 450V
Voltage consumption	continuous : 1.2 times instaneous : 2 times/10S
Voltage overload	< 1 VA (each phase)
Voltage Imdepance	5 300KΩ
Voltage Accuracy	RMS measurement , Accuracy : 0.5% F.S
Rated Ampere	3*5(6)A
Current overload	Continuous : 1.2 times , Instaneous : 10 times/10s
Current consumption	< 0.4 VA (each parameter) Current impedance <20mΩ
Current Accuracy	RMS measurement , Accuracy : 0.5% F.S
Frequency	45~60Hz、 Accuracy: 0.1Hz
Energy	Active power accuracy: 1% F.S , Reactive power accuracy : 2% F.S
Power	Active power/Reactive power/Apparent power accuracy : 0.1%F.S
Display	Programmable setting , shift , 320*240 TFT color LCD display
Power supply	AC/DC 100~240V Power consumption 68VA
Output digit interface	RS485 Modbus RTU protocol , print output port RS232
Alarm output	2 loop switch output , 250V AC/3A or 30V DC/5A
Analog output	One loop 4-20mA DC analog output
Working/Storage Environment	Working environment : -10°C~+50°C , Temperature <85%RH No frost Storage: -20°C~+55°C , Temperature <75%RH No frost
Anti-jamming	Electrostatic interference resistance ability : IEC61000-4-2, Level 2 Radiation anti-jamming capacity: IEC61000-4-3, Level 3 Fast transient pulse interface: IEC61000-4-4, Level 4 Surge immunity (1, 2/50us-8/20us) : IEC61000-4-5, Level 4
Isolation&puncture	Input signal and power 2000V AC , Input and output 2000V AC , power and transformed analog output 2000V DC RS485 communication , each isolated voltage or I/O 600V DC
Insulation	Input/output/power supply to meter cover >5MΩ
Dimension(mm)	96Wx96Hx105L

Menu Operation

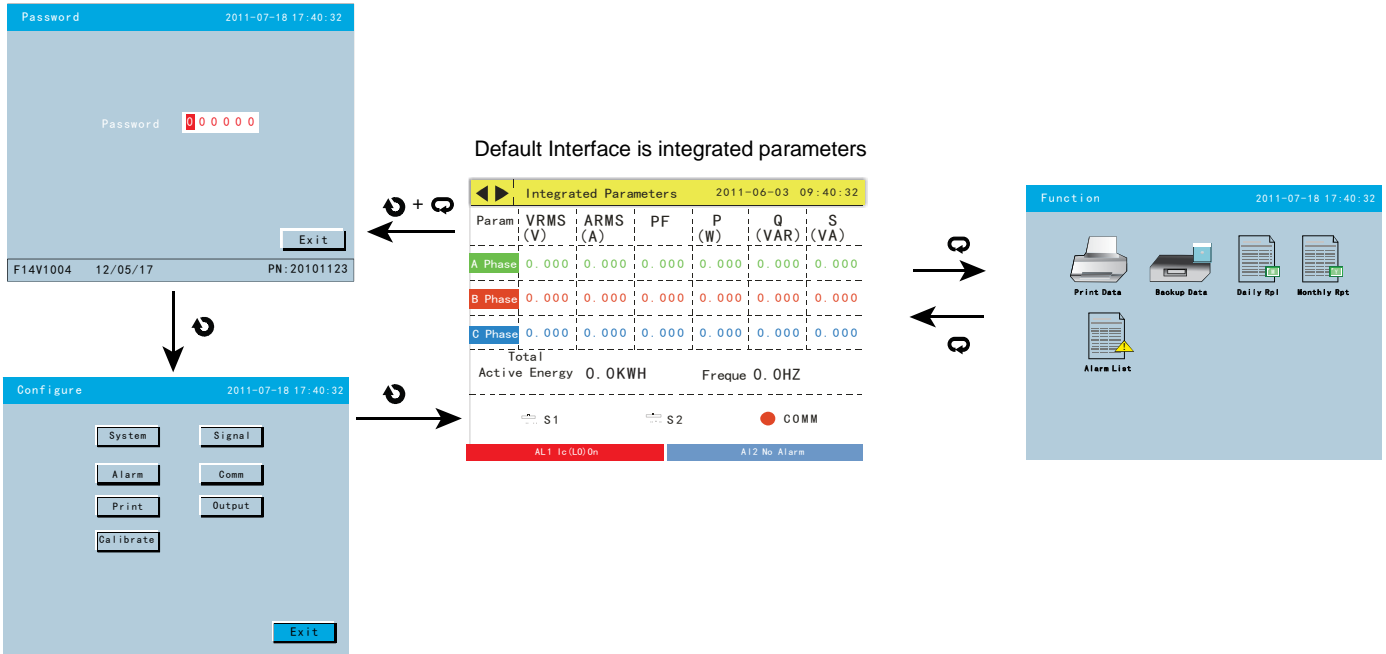

Data Record Report From Output Operation

1. The submenu operation method

In any measure interface, press **ESC** key to enter function list interface, and then press **←/→** to choose the submenu accordingly. When the icon blow line letter show black background, press **ENTER** to enter operation interface accordingly. Then press **←/→** to choose parameters to be modified. When the data frame in blue background, press **↑/↓** to modify the value. After finishing modification, press **ENTER** to confirm the setting. And press **ESC** to exit the operation interface.

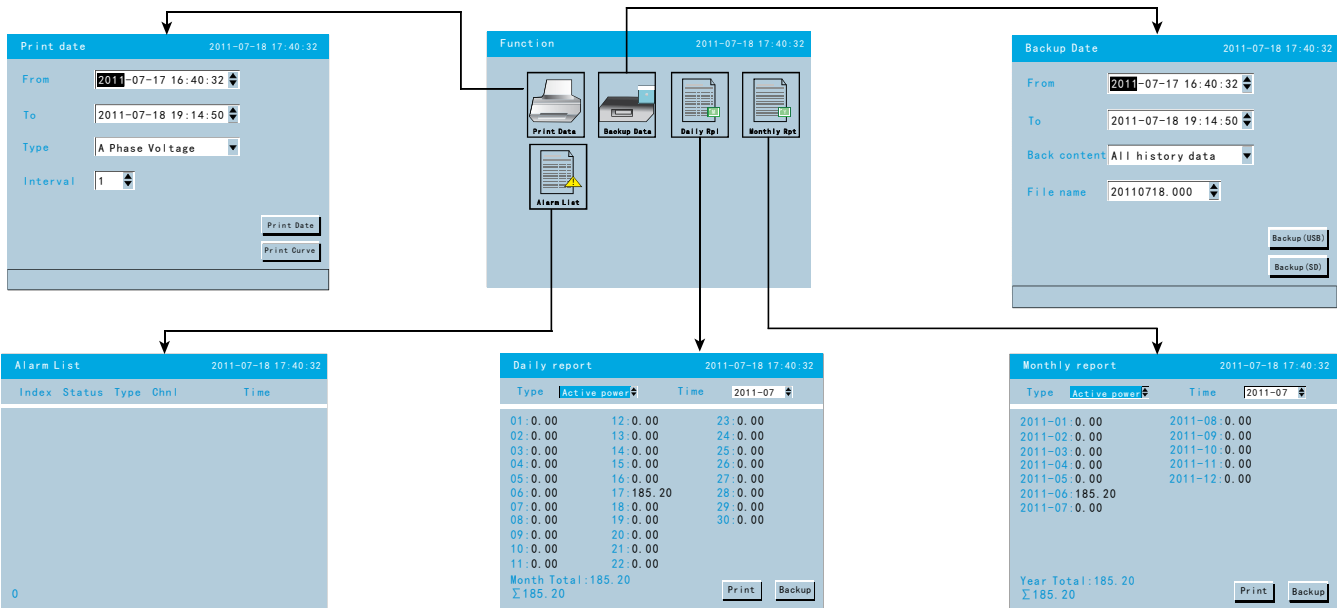

Data Printing and Backup Operation

1. Data print operation

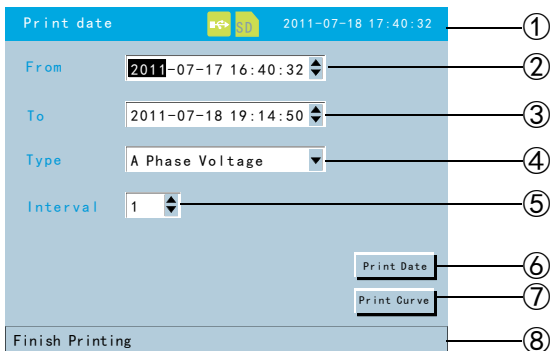

Print steps:

1. Connect micro-printer well.
2. Set start time and end time, press **←/→** to move the cursor to corresponding time, then press **↑/↓** to modify time.
3. Set data print type, move cursor to this item, then press **↑/↓** key to select the type, and press **ENTER** to confirm.
4. Print curve and data, exit to function list interface.

2. Data Backup Operation

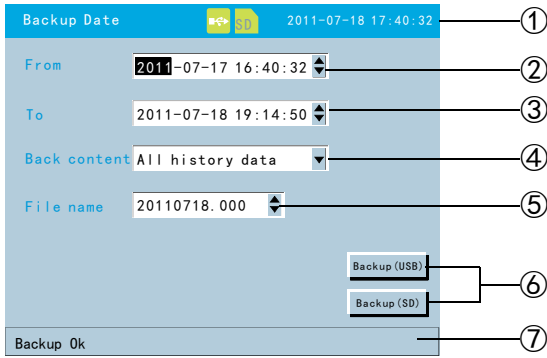

1. Status bar shows interface name , USB & SD card connection status
2. From : Data backup start time
3. To : Data backup end time
4. Backup content : include all history data record , alarm record , accumulated daily report form , monthly report form .
5. Backup file name : present data + file serial number.
6. Backup the file to USB or SD card , support maximum memory capacity 1GB.
7. Backup progress bar and backup status display.

Backup by manual

1. Ensure USB or SD card connect well with power recorder , check the SD card or USB status remind on the status bar.
2. Set backup data start time , the same setting way with printing.
3. Set backup data finish time , the same setting way with printing.
4. Set the backup file content .
5. Confirm the file name , file name format , data and serial number.
6. Move cursor to backup USB or SD card , and press **↵** to confirm backup.
- 7 . Press **⏪** key to return function list interface after finish backup.

Auto-Backup

1. When insert the SD card to power recorder, and it reminds that the status is normal , then the recorder will backup the data to the SD card automatically at 0:00 and 12:00 every day.
2. During backup , it will appear a red progress bar , after finishing backup , the progress bar will disappear. If backup failed or SD card is full , it will keep display red progress bar.

■ Meter Parameters Setting Operation

Submenu operation in configuration setting interface

In measuring status , press **⏪** + **⏩** to enter into code password interface. Press **↵** to confirm password and enter configuration setting interface. In the interface , press **⏪** or **⏩** to choose submenu to be operated. When the corresponding setting frame show blue background , press **↵** to choose operation menu. In operation interface , press **⏪** or **⏩** to choose the data frame to be modified. When it has blue background , press **⏩** / **⏪** to modify value or press **↵** to show data input dialog box . In dialog box , press **⏪** or **⏩** to select to delete , cancel or modify operation. After finishing value modification , press **⏪** to return the operating menu. Press **↵** to confirm and exit the interface . It will appear whether save the dialog box , select yes to storage the value and exit.

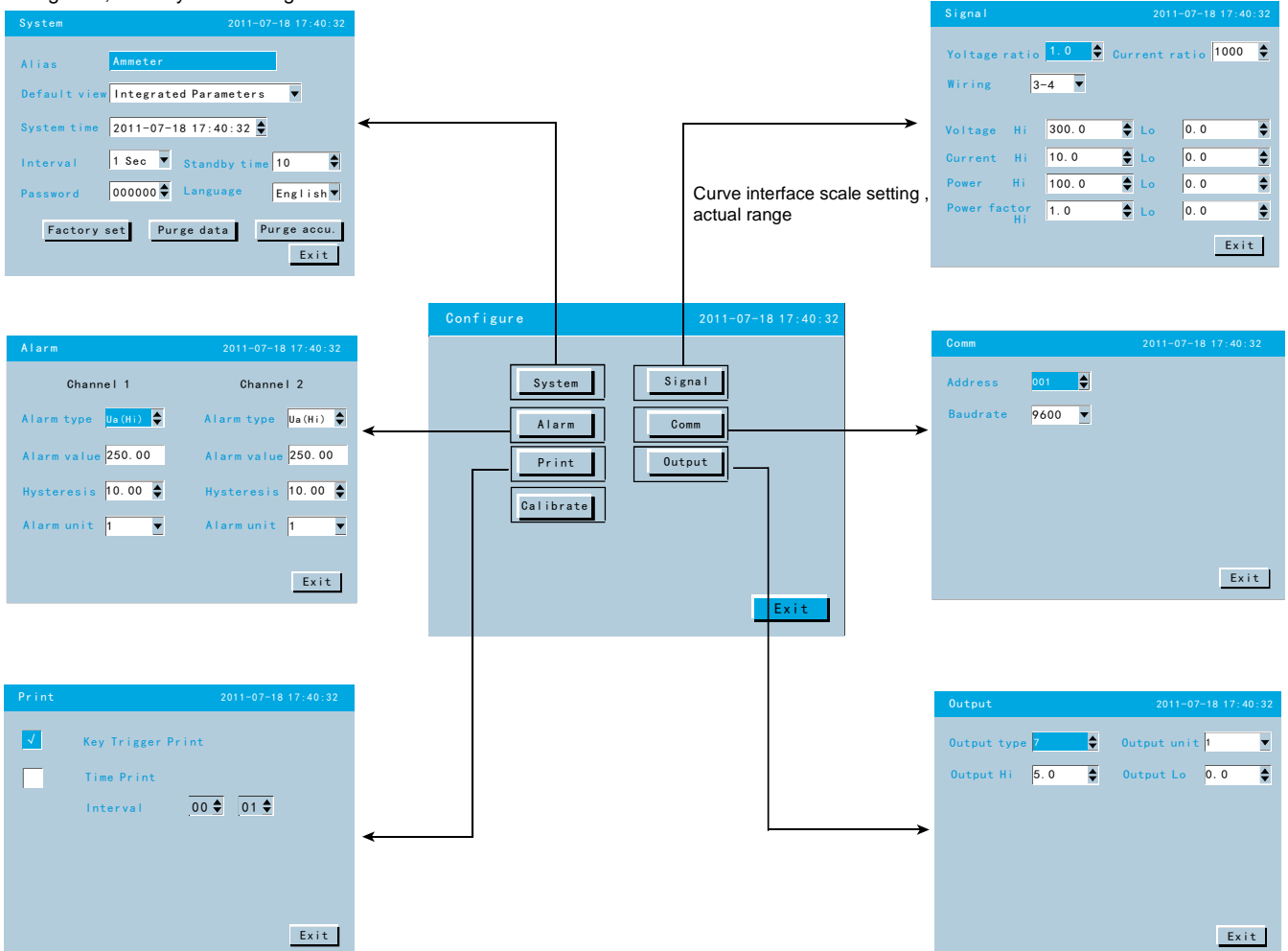

Configuration Setting Menu Function

No.	Menu	Submenu	Description
1	System	Alias	Can modify the name of the meter , ex-factory setting is 3 phase power recorder
		Default view	Main display interface , integrated parameters is default screen
		System time	system modification data and time
		Interval	Curve record time interval, default is 1second
		Standby time	screen display rest delay time , when set as 0 , no display rest delay function , default value is 10mins
		Password	Password modification . The password can be modified , ex-factory setting is 000000
		System language	Chinese and English can be shift
		Factory set	Recorder will return all parameters to factory setting when confirm this function.
		Purge data	Clear all the record data
		Purge accu	Clear accumulated power energy to zero
2	Signal	Voltage ratio	Voltage ratio (PT) , default setting is 1
		Current ratio	Current ratio (CT) , default setting is 1
		Wiring	Input signal net , 3 phase 3 wire , 3 phase 4 wire . Default setting is 3 phase 4 wire
		Voltage Hi and Lo	Input voltage high limit and low limit , default setting is 300 and 0
		Current Hi and Lo	Input current high and low limit , default setting is 10 and 0
		Power Hi and Lo	Each phase power high and low limit , default setting is 100 and 0
		Power factor Hi and Lo	Each phase power factor low and high limit , default setting is 1 and 0
3	Alarm	Alarm type	2 alarm setting , totally 52 choice. No alarm is DO1 and DO2 accordingly. Defaulting setting is Ua (high)
		Alarm value	2 loop alarm value setting , default setting is 250.0
		Hystersis	2 loop alarm hystersis setting , default setting is 10.0
4	COMM	Alarm unit	2 loop alarm unit setting , 1. International standard unit K: 1000 times than the international standard unit. Default setting is 1
		Address	Recorder communication address , range is 0-255 , default setting is 1
		Baudrate	Baud setting : 4800 , 9600 , Default setting is 9600
5	Print	Key Trigger print	Print by manual, select the print mode required to print by manual based on requirement. Default setting is key trigger print.
		Time print	Timing print , print based on set time interval
		Interval	The interval time for timing print . Unit is minute .
6	Output	Output type	Analog output mode selection , see attached form 1 , default setting is 7
		Output Unit	Analog output unit , 1: international standard unit K : 1000 times than international standard unit . Default setting is 1
		Output Hi	Analog output high limit , default setting is 5.0
		Output Lo	Analog output low limit , default setting is 0

■ Modify Meter Name

Input interface

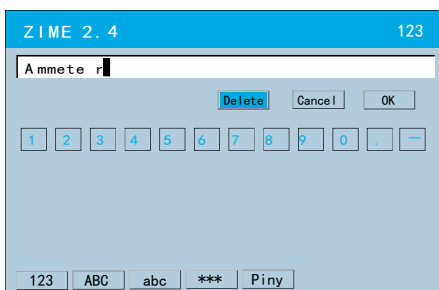

There are three type modification : Adjust input name , edit input name and slect input name

There are number , capital letter , small letter , symbols etc to choose.

Input panel operation :

« /» Move the soft keyboard cursor (include function , type method , PinYin or character choice)

Measure & Record Interface Operation

Integrated Parameters Interface

Param	VRMS (V)	IRMS (A)	PF	P (W)	Q (VAR)	S (VA)
A Phase	0.000	0.000	0.000	0.000	0.000	0.000
B Phase	0.000	0.000	0.000	0.000	0.000	0.000
C Phase	0.000	0.000	0.000	0.000	0.000	0.000
Total	Active Energy 0.0KWH		Freque 0.0HZ			

S1 S2 COMM
AL1 LoLOn A12 No Alarm

Power Display Interface

	P (W)	Q (VAR)	S (VA)
A	0.000	0.000	0.000
B	0.000	0.000	0.000
C	0.000	0.000	0.000

Voltage , Ampere , Power Factor Interface

	P (W)	Q (VAR)	S (VA)
A	0.0	0.000	0.000
B	0.0	0.000	0.000
C	0.0	0.000	0.000

Ampere Real Time Curve

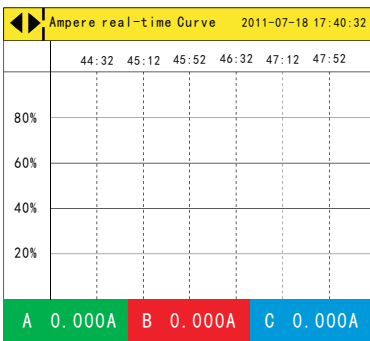

Voltage Real Time curve

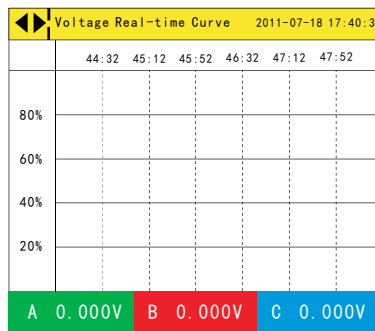

Total 3 phase Parameters Interface

Parameter	Value	Unit
Total Active Energy	0.000	KWH
Total Reactive Energy	0.000	KAVRH
Total Active Power	0.000	W
Total Reactive Power	0.000	VAR
Total Power Factor	0.000	

Power Factor Real Time Curve

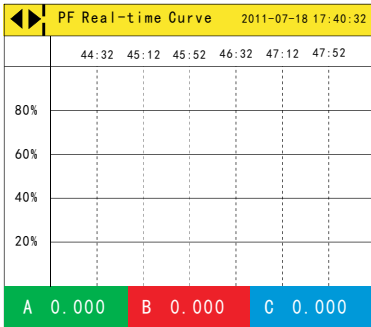

Active Power Factor Real Time Curve

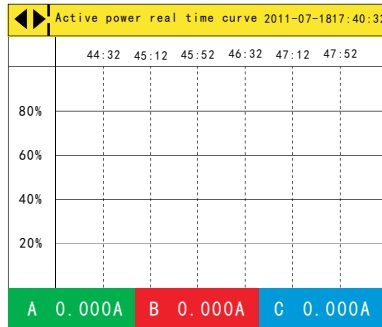

Voltage History Curve

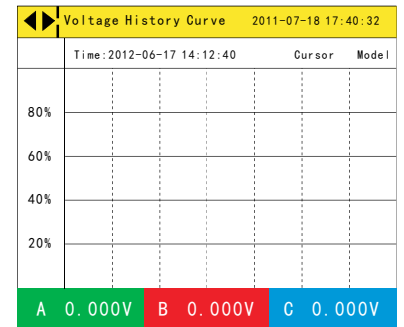

Active Power History Curve

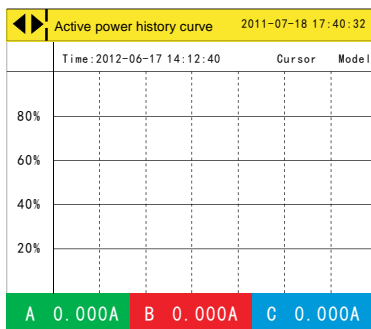

Power Factor History Curve

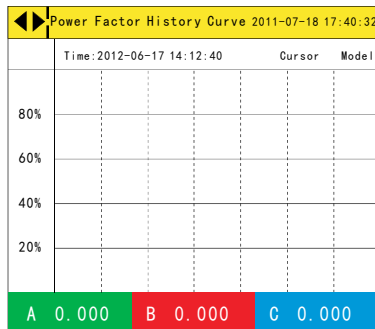

Ampere History Curve

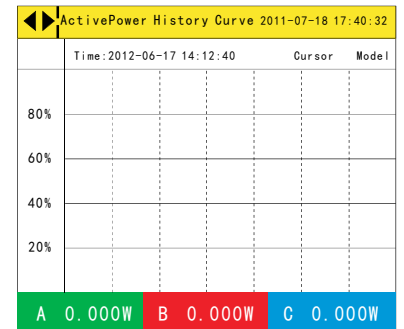

Return to integrated Parameters

Curve Record Interface Operation

1. Real time curve display example

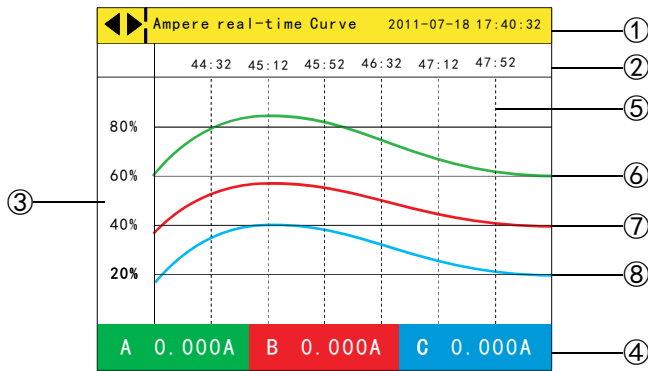

1. Status bar display
Display interface name , data and time
◀▶ : means use ◀ or ▶ key to shift the display interface.
- 2: real time of the record
- 3: curve display percentage scale
- 4: present interface curve corresponding measure value.
5. grid : easy for check record curve in each grid or layout
6. A phase real time record curve , the color is the same with A phase measuring data
- 7: B phase real time record curve , the color is the same with B phase measuring data.
- 8: C phase real time record curve , the color is the same with C phase measuring data

2. History curve record example

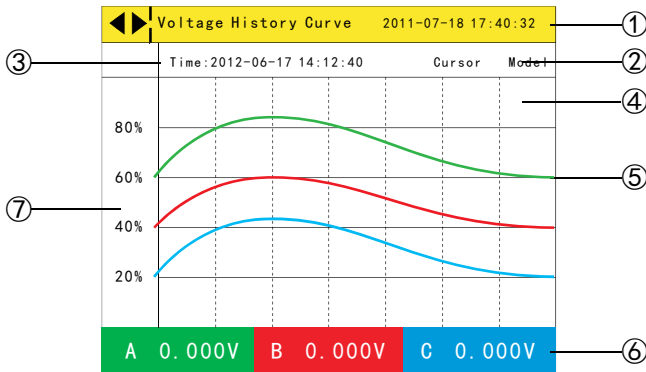

1. Display history record interface name , data and time
2. Data recall mode : recall mode and cursor mode . Press ⏪ to shift the mode.
3. Recall time : present cursor corresponding time .
4. Recall bar : convenient for user to locate time and data . In cursor mode , press ⏪ / ⏩ to move location to left and right.
5. Data history curve , display 3 phase data by three different curve
6. 3 phase history data : Display the history data of recall bar located position.
7. Scale : curve display percentage scale

Output Function

1. Energy pulse

DR9 provides function of energy calculation , 2 loop AP , AR energy pulse output and RS485 digit interface to finish long distance transmit of energy data. The energy pulse of optical couple relay with open collector enables the long distance transmit of active energy AP and reactive energy RP . Remote PC terminal , PLC , DI on-off output and collector module are applied to collect pulse of coulometer to enable the energy accumulation calculation . Besides , this output mode is also the energy accuracy check way (national metrology regulations : standard meter pulse tolerance comparison method)

(1). Electrical characteristic : the output of optical couple relay with open collector , V , 48V , I_z , 50mA

(2). Pulse constant : 7200imp/kwh . It means the impulse output No. is 7200 when the coulometer counts up to 1KWH in the point should be emphasized is that the above 1kwh is for the 2nd coil energy . Supposed that PT and CT is connected , the primary coil energy that 7200 pulse refer to is equal to 1kwh X voltage transform PT X current transform CT. (Note: when input PT voltage is 100V , pulse constant is 2800imp/kwh)

2. DI/DO function 2 way S1-S2 be used to remote control electric ON/OFF status , 2 loop DO1 , DO2 function be used to control electric device, when using DO function and alarm mode is setted as 0 , otherwise DO1 and DO2 will be as AL1, AL2 output . DO1 DO2 function control value can be written via RS485 interface.

3. Print output: Connect Micro printer interface to RXD , TXD and COM terminal of recorder based on RS232 mode. Then go to function interface to select printing and make sure that printer connect well with meter , to realize the printing operation. (printer is Nominated)

4. Communication function (please refer to the communication protocol)

5. Transform output (please refer to table 1)

6. Alarm function (please refer to table 1)

7. Data record report output , backup the data to SD card or USB . We offer software to make analysis the data on PC.

Communication Protocol

DR9 Series coulometer adopts Modbus RTU communication protocol RS485 half duplex communication , read function code 0x03 , write function code 0x10 , adopts 16 digit CRC check , the coulometer does not feedback for ECC error.

Data frame format is as blow :

Start bit	Data bit	Stop bit	Check bit
1	8	1	No

Abnormal communication handling :

When response is abnormal , the highest bit function code will be set as 1. For example , if the request function code from master is 0x04 , and the function code back from master is 0x84

Error code type

0x01- Function code error: Meter does not support the received function code

0x02-Data position error: The data position assigned by master is out of the range of meter.

0x03-Data value error: The data value sent from master is out of range of the meter

1. Read Multi-register

For example , master reads floating data AL1 (1st alarm value 241.5)

The address code of AL1 is 0x0000 , because AL1 is floating data (4 byte) , seizes 2 data register . According to IEEE-754 , the standard hexadecimal memory code of decimalist floating data 241.5 is 0x00807143

Master Request(read multi-register)							
1	2	3	4	5	6	7	8
Meter address	Function code	Start address high bit	Start address low bit	Data byte length high bit	Data byte length low bit	CRC code low bit	CRC code high bit
0x01	0x03	0x00	0x00	0x00	0x02	0xC4	0x0B

Slave Normal Answer (read multi-register)								
1	2	3	4	5	6	7	8	9
Meter address	Function code	number of data byte	data byte1 high bit	Data byte1 low bit	Data byte2 high bit	Data byte2 low bit	CRC code low bit	CRC code high bit
0x01	0x03	0x04	0x00	0x80	0x71	0x43	0x9E	0x7A

Function code abnormal answer (for example , master request function code is 0x04)

Slave Abnormal Answer (read multi-register)				
1	2	3	4	5
Meter address	Function code	Error Code	CRC code low bit	CRC code high bit
0x01	0x84	0x01	0x82	0xC0

2. Write multi-register

For example , Master reads float data HY1 (1st alarm hysteresis value 20.5) .

The address code of HY1 is 0x0001 , because HY1 is float data (4 bytes) , sizes 2 data registers. According to IEEE-754 standard , the hexadecimal memory code of decimalist float data 20.5 is 0x0000A441

Master Request (Write multi-register)												
1	2	3	4	5	6	7	8	9	10	11	12	13
Meter address	Function code	Start address high bit	Start address low bit	data byte length high bit	data byte length low bit	data byte length	data 1 high bit	data1 low bit	data 2 high bit	data 2 low bit	CRC code low bit	CRC code high bit
0x01	0x10	0x00	0x01	0x00	0x02	0x04	0x00	0x00	0xA4	0x41	0x88	0x93

Slave Normal Answer (Write multi-register)							
1	2	3	4	5	6	7	8
Meter address	Function code	Start address high 8 bit	Start address low 8 bit	Data byte length high bit	Data byte length low bit	CRC code low bit	CRC code high bit
0x01	0x10	0x00	0x01	0x00	0x02	0x10	0x08

Data position error answer (for example , master request write address index is 0x0050)

Slave Abnormal Answer (Write multi-register)				
1	2	3	4	5
Meter address	Function code	Error code	CRC code low bit	CRC code high bit
0x01	0x90	0x02	0xCD	0xC1

3. DR9 Parameter address reflection table

Note :Address is variable quantity number index

No.	Address reflection	Variable name	Default	Byte length	Value range	Read/Write	Remark
0	0x0000	1st alarm value AL1	250	2	-1999~9999	R/W	
1	0x0001	1st alarm hysteresis HY1	10	2	-1999~9999	R/W	
2	0x0002	2nd alarm value AL2	250	2	-1999~9999	R/W	
3	0x0003	2nd alarm hysteresis HY2	10	2	-1999~9999	R/W	
4	0x0004	Voltage transform PT	1.0	2	1~9999	R/W	
5	0x0005	Current transform CT	1.0	2	1~9999	R/W	
6	0x0006	Analog output high limit value RH	250	2	-1999~9999	R/W	
7	0x0007	Analog output low limit value RL	0.0	2	-1999~9999	R/W	
8	0x0008	Phase voltage Ua		2	0~9999	R	
9	0x0009	Phase voltage Ub		2	0~9999	R	
10	0x000A	Phase voltage Uc		2	0~9999	R	
11	0x000B	Line voltage Uab		2	0~9999	R	
12	0x000C	Line voltage Ubc		2	0~9999	R	
13	0x000D	Line voltage Uca		2	0~9999	R	
14	0x000E	Phase current Ia		2	0~9999	R	
15	0x000F	Phase current Ib		2	0~9999	R	
16	0x0010	Phase current Ic		2	0~9999	R	
17	0x0011	Phase A active power Pa		2	0.000~9999	R	
18	0x0012	Phase B active power Pb		2	0.0000~9999	R	
19	0x0013	Phase C active power Pc		2	0.000~9999	R	
20	0x0014	Total reactive power Ps		2	0.000~9999	R	
21	0x0015	Phase A reactive power Qa		2	0.000~9999	R	
22	0x0016	Phase B reactive power Qb		2	0.000~9999	R	
23	0x0017	Phase C reactive power Qc		2	0.000~9999	R	
24	0x0018	Total reactive power Qs		2	0.000~9999	R	
25	0x0019	Phase A apparent power VAa		2	0.000~9999	R	
26	0x001A	Phase B apparent Power VAb		2	0.000~9999	R	
27	0x001B	Phase C apparent power VAc		2	0.000~9999	R	
28	0x001C	Total apparent power VAs		2	0.000~9999	R	
29	0x001D	Power factor PFa		2	0~1.0	R	
30	0x001E	Power factor PFb		2	0~1.0	R	
31	0x001F	Power factor PFc		2	0~1.0	R	
32	0x0020	Total power factor PFs		2	0~1.0	R	
33	0x0021	Frequency		2	45~60	R	
34	0x0022	KWH		2	0.00-999999.99	R	
35	0x0023	KvarH		2	0.00-999999.99	R	

Reserve							
36	0x0051	1st alarm mode Ad1	2	1	0~52	R/W	Attached Table 1
37	0x0052	2nd alarm mode Ad2	2	1	0~52	R/W	
38	0x0053	Analog output mode brM	1	1	1~26	R/W	
39	0x0054	1st alarm unit	0	1	0~1	R/W	note 4
40	0x0055	2nd alarm unit	0	1	0~1	R/W	
41	0x0056	Analog output unit	0	1	0~1	R/W	
42	0x0057	Wiring mode/Link	0	1	0~1	R/W	note 1
43	0x0058	Baudrate	1	1	0~1	R/W	note 2
44	0x0059	Meter address	1	1	0~255	R/W	
45	0x005A	Switch output DO1, DO2		1	0~3	R/W	Remote control
46	0x005B	Switch input S1, S2		1	0~3	R	Remote control
47	0x005C	Meter name	0xD9	1	0xD9	R	
48	0x005D	Measure status indication		1	0~16	R	Note 3

Reference table 1: Reference table for alarm output and analog output

No.	Parameter	Switch output code (low alarm)	Switch output code (high alarm)	Analog output code 4-20mA
1	Ua (A phase voltage)	1	2	1
2	Ub (B phase voltage)	3	4	2
3	Uc (C phase voltage)	5	6	3
4	Uab (AB wire voltage)	7	8	4
5	Ubc (BC wire voltage)	9	10	5
6	Uca (CA wire voltage)	11	12	6
7	Ia (A wire current)	13	14	7
8	Ib (B wire current)	15	16	8
9	IC (C wire current)	17	18	9
10	Pa (A phase active power)	19	20	10
11	Pb (B phase active power)	21	22	11
12	PC (C phase active power)	23	24	12
13	Ps (total active power)	25	26	13
14	Qa (A phase reactive power)	27	28	14
15	Qb (B phase reactive power)	29	30	15
16	Qc (C phase reactive power)	31	32	16
17	Qs (total reactive power)	33	34	17
18	Sa (A phase apparent power)	35	36	18
19	Sb (B phase apparent power)	37	38	19
20	Sc (C phase apparent power)	39	40	20
21	Ss(total apparent power)	41	42	21
22	PFa (A phase power factor)	43	44	22
23	PFb (B phase power factor)	45	46	23
24	PFc (C phase power factor)	47	48	24
25	PFs (total power factor)	49	50	25
26	Frequency	51	52	26

Note 1 : connection mode

Communication value	0	1
Menu display	3-4	3-3

Note 2 : Baud rate

Communication value	0	1
Menu display	4.8	9.6

Note 4 : Alarm/Analog Unit

Communication value	0	1
Menu display	1	K

Remark 3 : Measure status indication

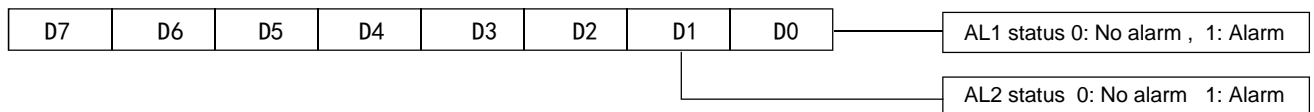

The program of 4 byte character code float data converting to decimalist float data

```
float BytesToFloat (unsigned char*pch)
{
    float result;
    unsigned char *p;
    p=(unsigned char*)&result;
    * p=*pch;* (p+1)=*(pch+1) ;*(p+2)=*(pch+2) ;*(p+3)=*(pch+3) ;
    return result;
}
```

The program of decimalist float data converting to 4 byte character code float data as per IEEE-754 standard

```
void FloatToChar (float Fvalue, unsigned char*pch)
{
    unsigned char*P;
    p=(unsigned char*)&Fvalue;
    *pch=*p;* (pch+1)=*(p+1) ;*(pch+2)=*(p+2) ;*(pch+3)=*(p+3) ;
}
```

The program of achieving 16 bit CRC check code

```
unsigned int Get_CRC (uchar*pBuf,uchar num)
{
    unsigned i, j;
    unsigned int wCrc=0xFFFF;
    for (i=0; i<num; i++)
    {
        wCrc^=(unsigned int) (pBuf[i]);
        for (j=0; j<8; j++)
        {
            if (wCrc &1) {wCrc>>=1; wCrc=0xA001;}
            else wCrc>>=1;
        }
    }
    return wCrc;
}
```

Dimension and Mounting Size

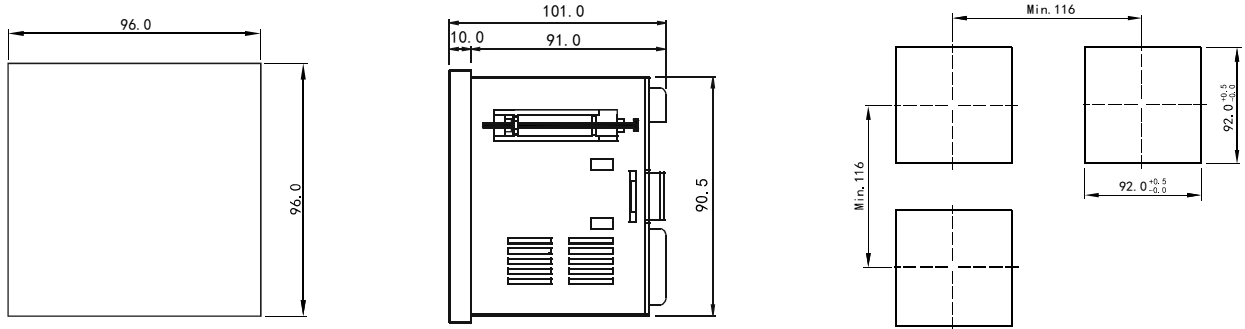

Connection Drawing

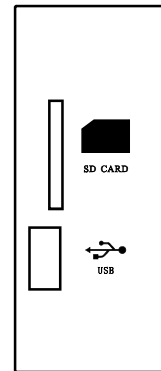
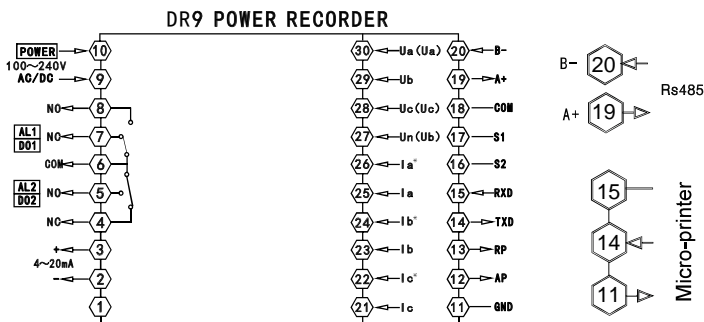

SD card and USB connection drawing

Note : before inserting SD card , please use FAT32 format SD

Note: If there is any change , please turn to the correct diagram on the meter.

Model 1: (3pcs CT) 3 phase 4 wire working mode with central line

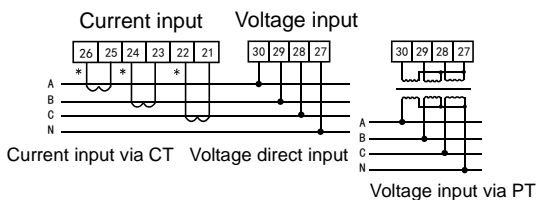

Model 2: (2pcs CT): 3 phase 3 wire working mode

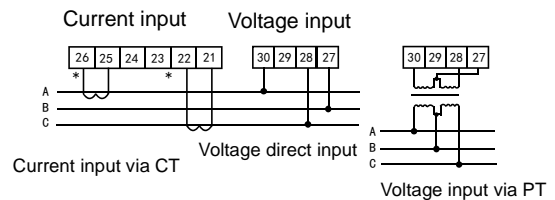

Explanation :

- Voltage input: Input voltage should not be higher than the rated input voltage of meter, otherwise a PT should be used.
- Current input: Standard rated input current is 5A. A CT should be used when the input current is bigger than 5A. If some other meters are connected with the same CT , the connection should be serial for all meters.
- Please make sure that the input voltage is corresponding to the input current, they should have the same phase sequence and direction, otherwise data and sign error may occur (power and energy).
- The connection mode of meter which is connected to power network should depend on the CT quantity. For 2pcs of CT, it should be 3 phase 3 wire connection. For 3pcs of CT, it should be 3 phase 4 wire connection.
- Please pay high attention on the difference between 3 phase 3 wire and 3 phase 4 wire connection , because wrong connection may lead to incorrect calculation of power factor, power and energy .

Caution:

- Power supply connection must be correct.
- Pay attention on the phase sequence of voltage signal input.
- Current signal input should be connected as per the connection link.
- Connection mode should accord to the setting of user menu link.
- Energy pulse output is open collector output.
- Isolation between power supply and circuit board, in case of leakage switch mis-action.