

Intelligent Temperature Controller User Manual

Applicable for AI208X-B version



Features

- Optional input signal types.
- PID arithmetic and with auto-tuning function.
- Different control types (please refer OT parameters).
- RUN/STOP function can be switch.
- Heating and cooling dual output suitable for extruder control.

National High-tech Enterprise/ National Standard Drafting Unit
 Hotline: 400-0760-168 Version code:KKAI208X-B02E-A/0-20241009

The instruction explain instrument settings, connections,name and etc, please read carefully before you use the temperature controller. Please keep it properly for necessary reference.

I. Model Illustration

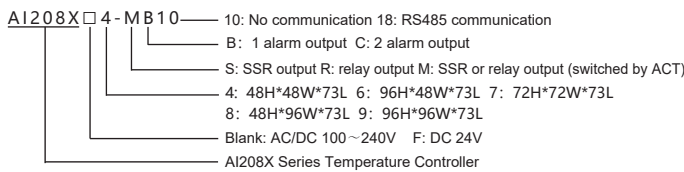

Note: When selecting the 4 size model with RS485 communication, the output can only be selected as S or R, which means one relay output or one SSR output

II. Order Information

Model	OUT1 Control output		Alarm		Communication	
	RELAY	SSR	AL1	OUT2	AL2	RS485
AI208X-4-RC18	●		●			
AI208X-4-SC18		●	●		●	
AI208X-4-MC10	●	●	●		●	
AI208X-4-MB10	●		●			
AI208X-6/7/8/9-MC10	●	●	●		●	
AI208X-6/7/8/9-MB10	●	●	●			
AI208X-6/7/8/9-MC18	●	●	●		●	
AI208X-6/7/8/9-MB18	●	●	●			

III. Specifications

1. Electrical parameters:

Sample rate	2 times per second
Relay capacity	AC 250V /3A Life of rated load>100,000 times
Power supply	AC/DC 100 ~ 240V (85-265V), DC 24V
Power consumption	< 10VA
Environment	Indoor use only, temperature: 0~50°C no condensation, humidity < 85%RH, altitude<2000m
Storage environment	-10 ~ 60°C, no condensation
SSR output	DC 24V pulse voltage, load<30mA
Insulation impedance	Input, output, power VS meter cover > 20MΩ
ESD	IEC/EN61000-4-2 Contact ±4KV /Air ±8KV perf.Criteria B
Pulse triap anti-interference	IEC/EN61000-4-4 ±2KV perf.Criteria B
Surge immunity	IEC/EN61000-4-5 ±2KV perf.Criteria B
Voltage drop & short interruption immunity	IEC/EN61000-4-29 0% ~ 70% perf.Criteria B
Isolation voltage	Signal input, output, power: 1500VAC 1min, <60V low voltage circuit: DC500V, 1min
Total weight	About 400g
Cover material	The shell and panel frame PC/ABS (Flame Class UL94V-0)
Panel material	PET(F150/F200)
Power failure memory	10 years, times of writing: 1 million times
Panel Protection level	IP65(IEC60529)
Safety Standard	IEC61010-1 Overvoltage category II, pollution level 2, levelII (Enhanced insulation)

2. Measured signal specifications:

Input type	Symbol	Measure range	Resolution	Accuracy	Input impedance /auxiliary current
K	⌈	-50 ~ 999	1°C	0.5%FS±3digits	> 500kΩ
J	⌋	0 ~ 999	1°C	0.5%FS±3digits	> 500kΩ
E	⌈	0 ~ 850	1°C	0.5%FS±3digits	> 500kΩ
T	⌋	-50 ~ 400	1°C	0.5%FS±2°C	> 500kΩ
PT100	⌈	-200 ~ 600	1°C	0.5%FS±3digits	0.2mA
CU50	⌋	-50 ~ 150	1°C	0.5%FS±3°C	0.2mA
CU100	⌋	-50 ~ 150	1°C	0.5%FS±1°C	0.2mA

IV. Panel Illustration

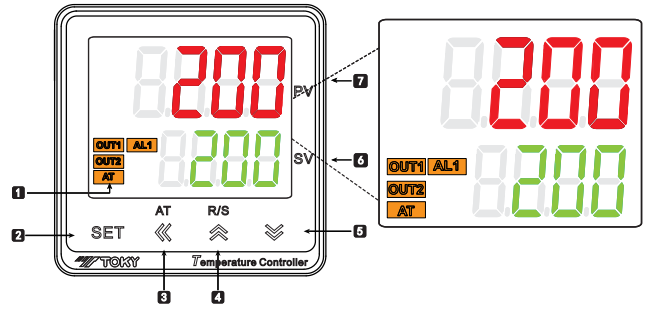

No.	Symbol	Name	Function
1	OUT1	OUT1 (Orange)	Main control output indicator, lights on when output ON.
	OUT2	OUT2 (Orange)	Cooling output indicator, lights on when output ON.
	AL1	Alarm 1# (Orange)	1st alarm output indicator, lights on when alarm output, lights off when no alarm output.
	AT	AT indicator(Orange)	Auto tune indicator, lights on when it is under auto tune status.
2	SET	SET key	Menu key/confirm key, to enter or exit the modification mode, or to confirm and save the modified parameter.
3	⏪	SHIFT/AT key	Activate key/ shift key/ AT auto tune key (in measure and control mode, long press to enter/exit auto tune)
4	⏩	UP key/ R/S	Add key, in measure and control mode, long press it to shift RUN/STOP mode, or check the menu in reverse order.
5	⏴	DOWN key	Reduce key, check the menu in sequence
6	SV	Display (green)	Set value / parameter display window, the control is stopped when it displays "STOP"
7	PV	Display (red)	Measured value/ parameter code display window

V. Dimension and installation size

1. Dimension

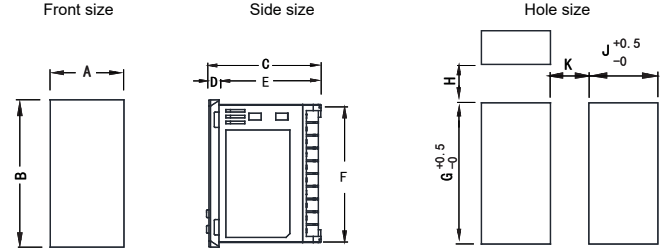

Model	A	B	C	D	E	F	G	H(Min)	J	K(Min)
4:(48*48)	48	48	73	6.5	66.5	44	45	25	45	25
6:(48*96)	48	96	73	6.5	66.5	90	91.5	25	45	25
7:(72*72)	72	72	73	6.5	66.5	66	67.5	25	67.5	25
8:(96*48)	96	48	73	6.5	66.5	44	45	25	91.5	25
9:(96*96)	96	96	73	6.5	66.5	90	91.5	25	91.5	25

2. Installation

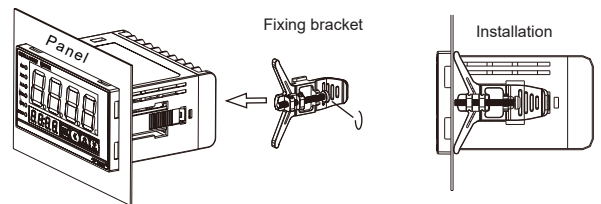

Installation method:Put the instrument into the cutout hole,and then place the fixing bracket on the installation slot of the instrument housing,push the brackte towards the panel until the instrument is fixed(the operation is as shown in the above)

VI. Connections

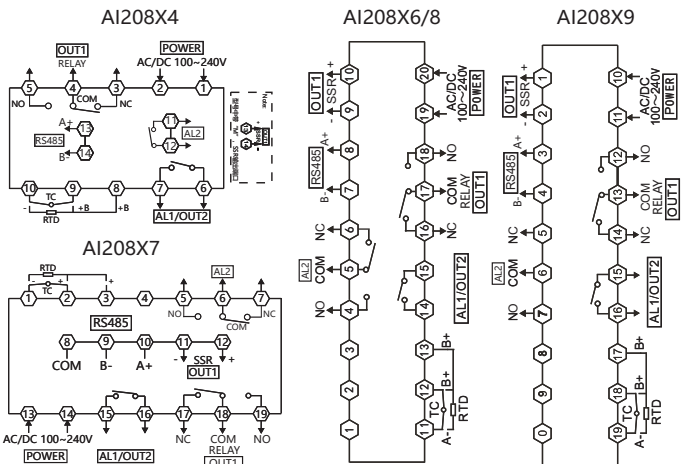

VII. Operation process and menu illustration

1. Operation process & method

1). Modify SV Value

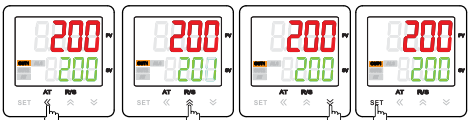

Press "←" SV value flash
 Press "↑" Increase SV value
 Press "↓" Reduce SV value
 Press "SET" Save SV value

2). Common Menu

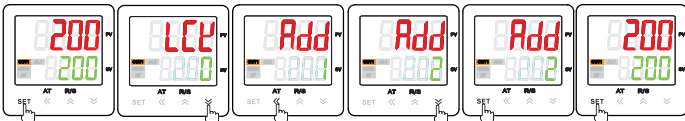

Press "SET" > 3 sec, enter Common Menu
 Press "←" or "→", move among menus
 Press "←", parameter value flash
 Press "←" or "→", modify parameter value
 Press "SET", save modified value
 Press "SET" > 3 sec, exit Common Menu

3). Advanced menu



Press "SET" > 3 sec, enter Common Menu
 Press "SET" to find LCK menu
 SET LCK=33
 Press "SET" to enter Advanced Menu
 Press "←", parameter value flash



Press "←" or "→", modify parameter value
 Press "SET", save modified value
 Press "SET" > 3 sec, exit Advanced Menu

VIII. Menu illustration

NOTE: The meter will hide unrelated parameters according to OT parameter setting. We suggest to set the OT parameter before using the meter for the first time.

□: No matter what model, what control mode it is, it will always display these parameters.
 □: According to different model, control mode, some parameters will be hidden.

1. Regular Menu

No.	Symbol	Name	Illustration	Setting range	Factory setting
1	AL1	AL1	1st alarm value. Note: the minus is dealt as absolute value when it is as deviation alarm.	FL ~ FH	10
2	HY1	HY1	1st alarm hysteresis	0 ~ 100	1
3	AD1	AD1	1st alarm mode. Note: when AL1 is used as OUT2, should set the value AD1=0 (close alarm function). When AD1>6, should set the value AD2=0 (excluding LBA alarms). Refer to the alarm function logic diagram	0 ~ 14	3
4	AL2	AL2	2nd alarm value. Note: the minus is dealt as absolute value when it is as deviation alarm.	FL ~ FH	5
5	HY2	HY2	2nd alarm hysteresis	0 ~ 999	1
6	AD2 (1)	AD2 (1)	2nd alarm mode, 7-12 has no function reserved, see table 1	0 ~ 14	4
7	LBA	LBA	Control circuit fault alarm time, unit: seconds	0 ~ 999	0
8	LBD	LBD	Control circuit fault alarm does not sense temperature band, unit: °C or °F	0 ~ 999	0
9	LBF	LBF	Control circuit fault alarm judgment amplitude, unit: °C/LBA or °F/LBA	0 ~ 999	0
10	PS	PS	Display correction value, display value= actual measured value + display correction value	-199 ~ 999	0
11	INP	INP	Optional input measured signal type: refer to input signal parameters table. Note: after the setting, need to modify other relevant parameters too.	K ~ CU100	K
12	OT	OT	Control method. 0: ON/OFF heating control, related parameters: DB; 1: PID heating, related parameters: P, I, D, OVS, CP, ST, PDC; 2: ON/OFF cooling control, related parameter DB; PT needs to be set during compressor control 3: PID heating and cooling (cooling control OUT2, it will be output through AL1 relay), related parameters: P, I, D, P1, OVS, CPCP1, PC, ST, PDC; 4: Over-temperature cooling output, related parameters: DB; 5: PID cooling, related parameters: P, I, D, OVS, CP, ST, PDC	0 ~ 5	1
13	P	P	Proportional band. The smaller the value is, the faster the system responds, otherwise, it is slower. Increasing proportional band can reduce the oscillation, but it will increase the control deviation. Reducing proportional band can reduce control deviation, but it will cause oscillation	0 ~ 999	30
14	I	I	Integral time. The smaller the value, the stronger the integral action, the better performance on eliminating the deviation between PV and SV. If the integral action is too weak, the deviation might not be eliminated. Unit: sec.	0 ~ 999	120
15	D	D	Differential time. Reducing it to a suitable value can prevent the oscillation of the system. The greater the value, the stronger the differential action. Unit: sec	0 ~ 999	30
16	P1	P1	Cooling PID, when OT=3 (PID heating and cooling), the PID parameter of OUT2; Description as above	0 ~ 999	30
17	OVS	OVS	Overshoot limit. During PID control process, when PV (measured value) > SV(set value) + OVS(overshoot limit), force to close output. The smaller this value is, the smaller the PID adjustment range is, the worse the control stability is. Please set the appropriate value according to the actual situation.	0 ~ 999	5
18	DB	DB	ON/OFF control hysteresis(negative hysteresis position control); or cooling control and compressor cooling control dead zone. After change the INP setting, please change this parameter according to the decimal point position.	0 ~ 100	5
19	CP	CP	OUT1 control cycle, 1: SSR control output, 4-200: relay control output. 0.1-99.9 can be set to one decimal place, 100-150 are integers, Unit: s	1 ~ 150	20.0
20	CP1	CP1	OUT2 relay output cycle. 4.0-99.9 can be set to one decimal place, 100-150 are integers, Unit: s	4.0 ~ 150	20.0
21	PC	PC	OUT2 cooling proportionality coefficient. The higher of value, the stronger of cooling effect.	1 ~ 999	100
22	LCK	LCK	Lock function, 001:SV value can't be modified, 010: menu set value can be checked only, can't be modified, 033: enter the advanced menu. 123: menus reset to factory setting.	0 ~ 999	0

2. Advanced menu illustration

No.	Symbol	Name	Illustration	Setting range	Factory setting																											
23	ACT	ACT	Control execution type. 0: relay output. 1: SSR output	0 ~ 1	0																											
24	ST	ST	Auto-tune switch 0: work normally after power-on 1: automatically enter PID parameters auto-tune status after power-on; press and hold « AT key to exit auto-tune.	0 ~ 1	0																											
25	ATE	ATE	Self tuning algorithm selection, 0:90% self-tuning algorithm; 1: 50% self-tuning algorithm	0 ~ 1	1																											
26	ATT	ATT	Self setting timeout (Unit: minutes) If the self-tuning exceeds the set value, it will exit self-tuning and retain the PID parameters before self-tuning;	1~999	80																											
27	SPC	SPC	Application of Industry PID Parameters: The instrument is equipped with ten commonly used PID parameters in factory setting. Customers can provide industry, equipment, and other information to consult with after-sales personnel, and directly call the PID parameters from this menu	NUL, PDO-PD9	NUL																											
28	PT	PT	Compressor start delay time, unit: sec	0 ~ 999	0																											
29/30	AE1/AE2	AE1/AE2	Alarm extension function: Menu options: AE1/AE2=A × 1+B × 10 <div style="border: 1px solid black; padding: 5px; margin: 5px 0;"> <table border="1" style="width: 100%; border-collapse: collapse;"> <tr> <td style="width: 20px;">A</td> <td style="width: 20px;">B</td> <td style="width: 20px;">A</td> </tr> <tr> <td colspan="3">1. A: overlimit alarm and power on alarm inhibition</td> </tr> <tr> <td colspan="3">A Alarm handling method when displaying overlimit whether the alarm inhibition when powered on</td> </tr> <tr> <td>0</td> <td colspan="2">Alarm status remains the same</td> </tr> <tr> <td>1</td> <td colspan="2">Force alarm output</td> </tr> <tr> <td>2</td> <td colspan="2">Force alarm close</td> </tr> <tr> <td>3</td> <td colspan="2">Alarm status remains the same</td> </tr> <tr> <td>4</td> <td colspan="2">Force alarm output</td> </tr> <tr> <td>5</td> <td colspan="2">Force alarm close</td> </tr> </table> </div> 2. B: Alarm indication B=0: No alarm indication; B=1: When the alarm is triggered, the digital tube in the lower row of the measurement interface flashes to display the alarm information	A	B	A	1. A: overlimit alarm and power on alarm inhibition			A Alarm handling method when displaying overlimit whether the alarm inhibition when powered on			0	Alarm status remains the same		1	Force alarm output		2	Force alarm close		3	Alarm status remains the same		4	Force alarm output		5	Force alarm close		0~15	10
A	B	A																														
1. A: overlimit alarm and power on alarm inhibition																																
A Alarm handling method when displaying overlimit whether the alarm inhibition when powered on																																
0	Alarm status remains the same																															
1	Force alarm output																															
2	Force alarm close																															
3	Alarm status remains the same																															
4	Force alarm output																															
5	Force alarm close																															
31	FL	FL	Measure range low limit. The set value must be less than measure range high limit	Refer to measured signal table	-50																											
32	FH	FH	Measure range high limit. The set value must be more than measure range low limit.	Refer to measured signal table	999																											
33	SLL	SLL	Limit the low limit of the setting value range	FL~FH	FL																											
34	SLH	SLH	Limit the high limit of the setting value range	FL~FH	FH																											
35	DP	DP	Decimal point setting, it is effective below 100	0 ~ 1	0																											
36	FT	FT	Filter coefficient. The higher the value, the stronger the filter function.	0~255	10																											
37	UT	UT	Temperature unit conversion, Celsius/Fahrenheit	°C, °F	°C																											
38	DTR	DTR	PV fuzzy tracking value. Properly set this value on some occasions, it can get a more stable control display value, this value is unrelated with actual measured value. Note: after setting this value, when the alarm set value is equal to SV set value, alarm output operation is subject to actual measured value.	0.0~2.0	1.0																											
39	BAD	BAD	Communication baud 0 (4.8): 4800; 1 (9.6) : 9600; 2 (19.2) : 19200	0~2	1																											
40	ADD	ADD	Communication address	0~247	1																											
41	PRTY	PRTY	Communication checksum setting, 0: (NO) no checksum, 1: (ODD) odd checksum 2: (EVENT) Even checksum	0~2	NO																											
42	DTC	DTC	Communication data transmission sequence setting 000; The first function is reserved, the second is byte order exchange, and the third function is reserved	See communication protocol note ③	0																											
43	SSM	SSM	Enable R/S key to switch RUN/STOP operation. 0: Forbidden 1: Enable This setting is for panel operation only, not for communication operation.	0 ~ 1	1																											
44	VER	VER	Software version, Only read																													

IX. Alarm function logic diagram:

(1) Symbol illustration: "☆" means HY, "▲" means alarm value, "△" means SV value

Alarm code	Alarm mode	Alarm output (AL1 & AL2 are independent from each other) Image: the hatched section means the alarm action
0	Turn off alarm	
1	High limit absolute value alarm	
2	Low limit absolute value alarm	
3	※High limit deviation value alarm	
4	※Low limit deviation value alarm	
5	※High/low limit deviation value alarm	
6	※High/low limit interval value alarm	
7	High and low limit absolute value interval alarm	
8	※High and low limit deviation value interval alarm	
9	※High limit absolute value and low limit deviation value interval alarm	
10	※High limit deviation value and low limit absolute value interval alarm	
11	High/low limit absolute value alarm	
12	High/low limit deviation value alarm	
AD1/AD2 =14	LBA Alarm	Only effective when AD2=14 in OT=3 heating and cooling mode, At this point, the LBA alarm function requires the use of a second relay alarm <p>When the PV value is not within the range of [SV-LBD, SV+LBD]; When MV=100 and the PV rise within LBA time is less than LBF degrees, ① alarm When MV=0 and PV drops less than LBF degrees within LBA time, ② an alarm is triggered</p>

X. Key function operation

1. RUN/Stop mode

- Under the measure mode, press and hold "R/S" key > 3 sec to enter STOP mode, SV window will display "STOP". Under STOP mode, press and hold "R/S" key to exit STOP mode.
- Under STOP mode, support to modify SV value and switch operation.
- Under STOP mode, main control output will stop.

2. PID auto-tune operation:

- Usually, the default PID parameters of this product are not suitable for all occasions; please use auto-tuning function to get a suitable PID parameter.
- The meter will enter control output since the power on. please set the meter as STOP mode to not affect the auto-tuning result, or switch off the power of control output load. No matter how to operate, should ensure that the set value is greater than the current measured value; the greater the drop, the better.
- Before auto-tuning, please set the proper alarm value, or remove the alarm condition to avoid the effect of alarm output.
- Set SV value.
- Set parameter OT as 1 (PID control).
- Under the condition of PV value at normal room temperature, please exit STOP mode or input the load power, and keep pressing "AT" key to enter auto-tuning mode, then AT indicator turns on.
- Auto-tuning need a period, to ensure the auto-tuning result, please don't modify parameters or power-off during auto tuning.
- When AT light is off, it will exit the auto-tuning mode. PID will update automatically, and the meter will control automatically and precisely.
- During auto-tuning procedure, press "AT" key, measure beyond the range, display abnormally, shift to "STOP" mode, power-off will stop the auto-tuning.
- Experienced user can set the proper PID parameter with their rich experience.

3. PID heating & Cooling control operation (suitable for injection molding machine and extruder)

- Set the control mode OT to 3. (heating and cooling control)
- PID heating control act on OUT1; Cooling control act on OUT2.
- Cooling control OUT2 will make output by AL1 alarm relay.
- Please change the cooling control cycle CP1 to a more suitable value and adjust the cooling ratio coefficient PC to a more suitable value.

XI. Checking methods of simple fault

Display	Checking methods
LLLL/HHHH	Check whether: the sensor is in poor contact or wrong wiring, Check the FH/ FL value, Check the environment temperature whether is out of range, Check the input signal whether is selected correctly.(INP menu)

XII. Communication protocol

Meter adopts RS485 Modbus RTU communication protocol, Read function code 0x03 of the holding register in zone 04, write function code 0x10 or 0x06. Adopt 16 digit CRC check, the meter does not return for error check. The data type is a 16 bit signed or unsigned integer.

Data frame format:

Start bit	Data bit	Stop bit	Check bit
1	8	1	None/odd parity/even parity

1. Read register

For example: Host reads SV value (set SV=200)

The address code of SV is 0x2000 ("0x" represents for hexadecimal), because SV data type is a 16-bit integer (2 bytes), seizes 1 data register. The memory code of decimal integer 200 convert to hexadecimal code is 0x00C8. Note: when reading data, should confirm DP menu value first to ensure the decimal point position, after that transform the read data to get the actual value.

Read multi-register	Meter ADD	Function code	Start ADD High bit	Start ADD Low bit	Data byte Length high bit	Data byte Length low bit	CRC Code	CRC Code
Host request	0x01	0x03	0x20	0x00	0x00	0x01	0x8F	0xCA
Slave normal answer	0x01	0x03	0x02 bits		0x00	0xC8	0xB9	0xD2
Slave abnormal answer	0x01	0x83	0x02 error code		For example: Host request address is 0x2011		0xC0	0xF1

2. Write multi-register

For example: Host use 0x10 function code write SV value (SV=150)

Address code of SV is 0x2000, because SV data type is a 16-bit integer (2 bytes), seizes 1 data register. The decimal integer 150 convert to hexadecimal code is 0x0096. Before writing the data, you should convert the data to the corresponding magnification and then writing the data into the instrument.

Host request (write multi-register)										
Meter ADD	Function code	Start ADD High bit	Start ADD Low bit	Data byte Length high bit	Data byte Length low bit	Data byte Length	Data high bit	Data low bit	CRC code	CRC code
0x01	0x10	0x20	0x00	0x00	0x01	0x02	0x00	0x96	0x07	0xFC
Slave normal answer (write multi-register)										
Meter ADD	Function code	Start ADD High bit	Start ADD Low bit	Data byte length high bit	Data byte length low bit	※CRC code low bit	※CRC code high bit			
0x01	0x10	0x20	0x00	0x00	0x01	0x0A	0x09			

Host write SV with 0x06 function (set value 150)

Read single register	Meter ADD	Function code	Start ADD High bit	Start ADD Low bit	Data byte Length high bit	Data byte Length low bit	CRC Code	CRC Code
Host request	0x01	0x06	0x20	0x00	0x00	0x96	0x02	0x64
Slave normal answer	0x01	0x06	0x20	0x00	0x00	0x96	0x02	0x64
Slave abnormal answer	0x01	0x86	Function code		0x02 Error Code		0xC3	0xA1

Handling of abnormal communication:

When abnormal response, put 1 on the highest bit of function code. For example: Host request function code 0x03, and slave response function code should be 0x83.

Error code:

- 0x01---Illegal function: the function code sent from host is not supported by meter.
- 0x02---Illegal address: the register address designated by host beyond the address range of meter.
- 0x03---Illegal data: Data value sent from host exceeds the corresponding data range of meter.

Meter parameters address table

No.	Address(Register No.Ⓜ)	Variable name	Register	R/W	Remark
1	0x2000 (48193)	Setting value SV	1	R/W	
2	0x2001 (48194)	1st alarm value AL1	1	R/W	
3	0x2002 (48195)	1st alarm hysteresis HY1	1	R/W	
4	0x2003 (48196)	2nd alarm value AL2	1	R/W	
5	0x2004 (48197)	2nd alarm hysteresis HY2	1	R/W	
6	0x2005 (48198)	Display low limit FL	1	R/W	
7	0x2006 (48199)	Display high limit FH	1	R/W	
8	0x2007 (48200)	Setting value Low limit SLL	1	R/W	
9	0x2008 (48201)	Setting value high limit SLH	1	R/W	
10	0x2009 (48202)	Self tuning algorithm selection ATE	1	R/W	
11	0x200A (48203)	Self setting timeout period ATT	1	R/W	
12	0x200B (48204)	Overshoot limit OVS	1	R/W	
13	0x200C (48205)	Heat & Cool control dead zone DB	1	R/W	
14	0x200D (48206)	Proportional coefficient of cooling PC	1	R/W	
15	0x200E (48207)	Amend value PS	1	R/W	

Continue

No.	Address(Register No.Ⓜ)	Variable name	Register	R/W	Remark
16	0x200F (48208)	PV fuzzy tracking value DTR	1	R	
17	0x2010 (48209)	Measured value PV	1	R	
18	0x2011 (48210)	Output value MV	1	R	0~100
19	0x2012 (48211)	Cooling ratio coefficient P1	1	R/W	No decimal point
20	0x2013 (48212)	Control circuit fault alarm time LBA	1	R/W	
21	0x2014 (48213)	Control circuit fault alarm does not sense temperature band LBD	1	R/W	
22	0x2015 (48214)	Control circuit fault alarm judgment amplitude LBF	1	R/W	
Reserve					
23	0x2100 (48449)	1st alarm mode AD1	1	R/W	
24	0x2101 (48450)	2nd alarm mode AD2	1	R/W	
25	0x2102 (48451)	1st alarm extended function AE1	1	R/W	
26	0x2103 (48452)	2nd alarm extended function AE2	1	R/W	
27	0x2104 (48453)	Control mode OT	1	R/W	
28	0x2105 (48454)	Output mode ACT	1	R/W	
29	0x2106 (48455)	RUN/STOP operation	1	R/W	0:RUN 1:STOP 2:Run auto-tune 3:Stop auto-tune
30	0x2107 (48456)	Decimal point DP	1	R/W	
31	0x2108 (48457)	Unit display UT	1	R/W	25 (°C) 26 (°F)
32	0x2109 (48458)	Filter constants FT	1	R/W	
33	0x210A (48459)	Proportional coefficient P	1	R/W	No decimal point
34	0x210B (48460)	Integral time I	1	R/W	No decimal point
35	0x210C (48461)	Differential time D	1	R/W	No decimal point
36	0x210D (48462)	Application of Industry PID Parameters SPC	1	R/W	
37	0x210E (48463)	Heating control cycle CP	1	R/W	With 1 decimal place
38	0x210F (48464)	Cooling control cycle CP1	1	R/W	With 1 decimal place
39	0x2110 (48465)	Cooling delay time PT	1	R/W	No decimal point
40	0x2111 (48466)	Optional input signal INP	1	R/W	
41	0x2112 (48467)	Meter address ADD	1	R/W	
42	0x2113 (48468)	Communication baud BAD	1	R	
43	0x2114 (48469)	Com. data transfer sequence DTC	1	R	Note ③
44	0x2115 (48470)	Switch button RUNSTOP switch	1	R	
45	0x2116 (48471)	Lock LCK	1	R	
46	0x2117 (48472)	Meter name	1	R	
47	0x2118 (48473)	Output state	1	R	Note ②
48	0x2119 (48474)	Parity Check PRTY	1	R	

R: Read only; R/W: Read & write

Note①: The register number is the address converted to decimal plus 1 and then add in front of the register identification code 4; for example: the register number of the data address 0x2000 is 8192 + 1 = 8193 and then 4 is added in front, that is, the register number 48193; Related applications can be seen, such as Siemens S7-200 PLC.

Note ②: Measurement status indication. When the data bit is 1, it means execution, and when it is 0, it means no execution.

D8	D7	D6	D5	D4	D3	D2	D1	D0
AL3	STOP	HHHH	LLLL	AT	AL2	AL1	OUT2	OUT1

Note③: DTC communication data transmission sequence description

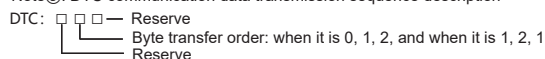

XIII. Version and Revision History

Date	Version	Revision content
2024.10.09	A/0 Version	1st edition

Manufacturer contact information: Toky Electrical Co., Ltd

Add: No.8 Minke West Rd, Shiqi District, Zhongshan, Guangdong, CN 528400

Contact: 0760-23371800

Technical consultation contact: 400-0760-168

Web: www.toky.com.cn