

# DR9 Series 3 Phase Multi-function Power Recorder Operation Manual



This meter can measure and record the true value of voltage , ampere , active power , reactive power , power factor , Kwh , KvarH ect. It also can generates various kinds of report forms . The parameters can copy to SD card or USB automatically or by manual .

With RS485 communication port , support modbus RTU. It can be widely used in SCADA system and energy management system , power station automation system , power grid , estate power monitor , intelligent building , intelligent switchboard and switch cabinet ect

For your safety , please read the content before usage.

## ■ Safe Caution

\* please read the manual carefully before using the meter .

※ Please comply with the below important points:

- △ Warning An accident may happen if the operation does not comply with the instruction.
- △ Notice An operation that does not comply with the instruction may lead to product damage.

\* The instruction of the symbol in the manual is as below:

△ An accident danger may happen in a special condition.

## △ Warning

1. A safety protection equipment must be installed or please contact with us for the relative information if the product is used under the circumstance such as nuclear control, medical treatment equipment ,automobile, train, airplane, aviation, entertainment or safety equipment, etc. Otherwise, it may cause serious loss, fire or person injury.
2. A panel must be installed, otherwise it may cause creepage (leakage).
3. Do not touch wire connectors when the power is on, otherwise you may get an electric shock.
4. Do not dismantle or modify the product, If you have to do so, please contact with us first. Otherwise it may cause electric shock and fire.
5. Please check the connection number while you connect the power supply wire or input signal, otherwise it may cause fire.

## △ Caution

1. This product cannot be used outdoors. Otherwise the working life of the product will become shorter, or an electric shock accident may happen.
2. When you connect wire to the power input connector or signal input connectors, the moment of the No.20AWG (0.50 mm<sup>2</sup>) screw tweaked to the connector is 0.74n.m-0.9n.m. Otherwise the connectors may be damaged or get fire.
3. Please comply with the rated specifications. Otherwise it may cause fire after the working life of the product becomes shorter.
4. Do not use water or oil base cleaner to clean the product. Otherwise it may cause electric shock or fire, and damage the product.
5. This product should be avoid working under the circumstance that is flammable, explosive, moist, under sunshine, heat radiation and vibration.
6. In this unit it must not have dust or deposit, otherwise it may cause fire or mechanical malfunction.
7. Do not use gasoline, chemical solvent to clean the cover of the product because such solvent can damage it. Please use some soft cloth with water or alcohol to clean the plastic cover.

## Features:

- 320\*340 TFT color LCD display.
- Measure 3 phase voltage , ampere , reactive power ,active power , apparent power , power factor , frequency , Kwh , KvarH ect.
- Three phase voltage , ampere , active power , reactive power ,and other parameters real time record and curve record storage
- Total Kwh and total KvarH accumulation memory function.
- Both side and outside storage , support SD card and USB storage , maximum storage is 8GB
- Switch output: AL1, AL2 relay switch output
- Analog output : one 4-20mA DC transmission output.
- Switch input :4 switch input S1-S4 , used in remote control the electric switch status.
- With RS485 communication , Modbus RTU
- Optional tariff statistics function, with demand statistics function.
- Optional harmonic analysis function (including the total harmonics).
- Backup data can be opened by PC software to show the real time curve record

## ■ Technical Parameters

Connection	3 phase 3 wires, 3 phase 4 wires
Voltage Range	AC 3x57.7V / 3X220V (note: Direct input volt: L-N: 0~600V, L-L: 0~1000V)
Voltage Overload	Continuous: 1.2 times Instantaneous: 2 times/10S
Voltage Consumption	<1VA (each phase)
Voltage impedance	≥300KΩ
Voltage Accuracy	RMS measurement , Accuracy : 0.5
Current Range	AC 0.025 ~ 5A
Current Overload	Continuous: 1.2 times Instantaneous: 4 times/10S
Current Consumption	<0.4VA (each phase)
Current impedance	<20mΩ
Current Accuracy	RMS measurement , Accuracy : 0.5
Frequency	40~60Hz、 Accuracy:0.1Hz
Energy	Active energy accuracy 0.5 / Reactive energy accuracy 1.
Power	Active power/Reactive power/Apparent power, accuracy: 0.5
Display	TFT color display
Power Supply	AC/DC 100 ~ 240V Power Consumption ≤8VA
Output Digit Interface	RS-485 Modbus-RTU Protocol
Alarm Output	4 On/Off output, 250VAC/3A or 30V DC/5A
Analog Output	1 transmission output, 4-20mA DC Load<400Ω
Working Environment	work temperature:-10°C~+45°C, Humidity<85%RH no condensation, Work temperature limit:-25°C~+55°C, Storage temperature:-25°C~+70°C,
Anti-jamming	Electrostatic interference resistance ability : IEC61000-4-2, Level 2 Radiation anti-jamming capacity: IEC61000-4-3, Level 3 Fast transient pulse interface: IEC61000-4-4, Level 4 Surge immunity (1, 2/50us-8/20us) : IEC61000-4-5, Level 4
Isolation&puncture	input VS power: AC 2000V, Power VS relay :AC 2000V, Power VS transmission output:DC 2000V, RS485 port, isolated low voltage or I/O: DC 600V
Insulation	Input/output/power supply to Meter cover >5MΩ
Dimension	96W×96H×100Lmm

## Instrument accessories

No.	Name	Quantity	Note	standard configuration
1.	install bracket	2	used for panel installation and fixing	standard configuration
2.	Operation Manual	1	Printed Manual	standard configuration
4.	PC software	1	Disk (USB/SD Card) suitable for Win2000/WinXP/WinVista/Win7	standard configuration
6.	USB	1	Maximum support 8GB	standard configuration
7.	SD	1	Maximum support 8GB	standard configuration

## ■ Dimension and Mounting Size

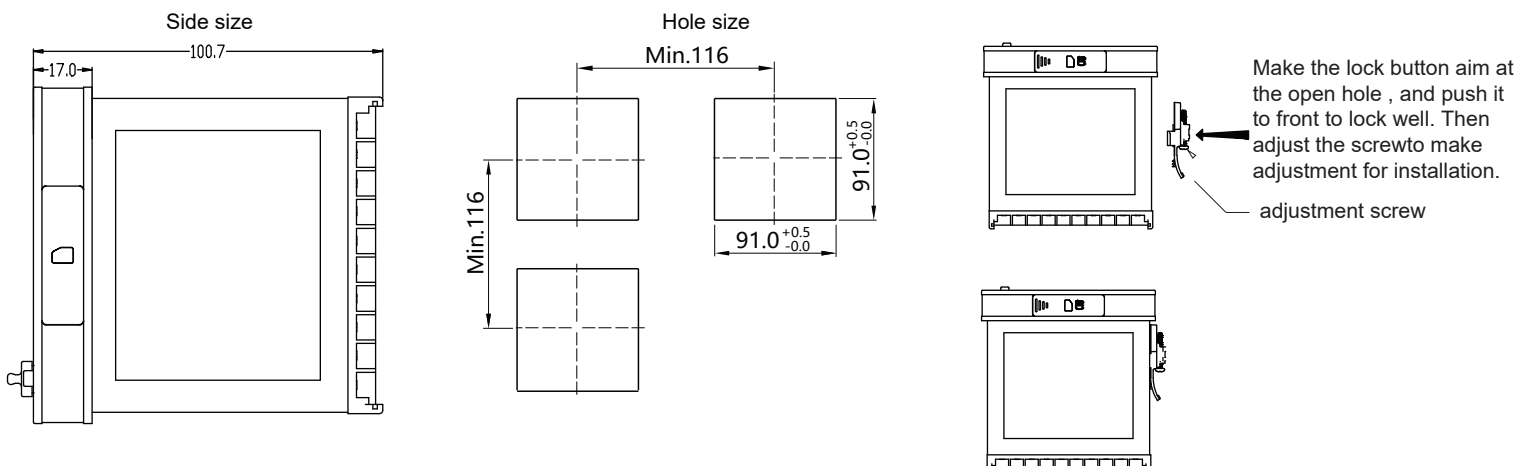

## Wire Connection

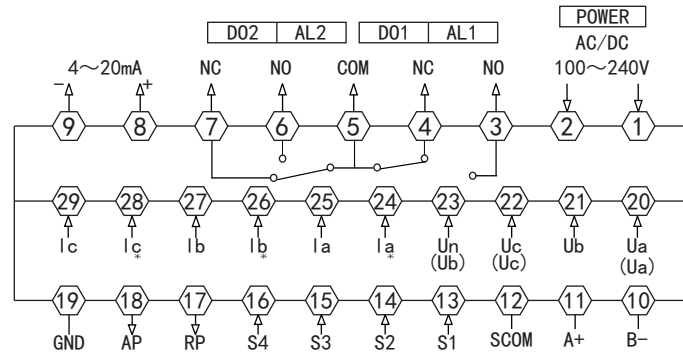

Note: 1. For voltage input connection terminal, bracket terminals (Ua) (Uc) (Ub) shows 3 phase 3 wire connection method, 2. Current input \* is current input terminal, all the inputs and outputs must be coherent

Model 1: (3pcs CT) 3 phase 4 wire working mode

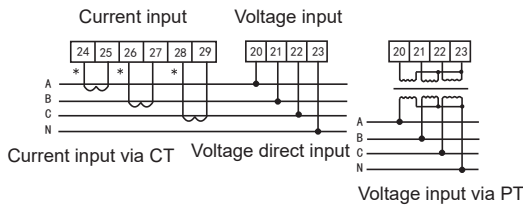

Model 2: (2pcs CT): 3 phase 3 wire working mode

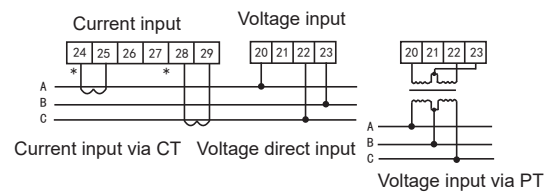

Explanation :

- Voltage input: Input voltage should not be higher than the rated input voltage of meter, otherwise a PT should be used.
- Current input: Standard rated input current is 5A. A CT should be used when the input current is bigger than 5A. If some other meters are connected with the same CT, the connection should be serial for all meters.
- Please make sure that the input voltage is corresponding to the input current, they should have the same phase sequence and direction, otherwise data and sign error may occur (power and energy).
- The connection mode of meter which is connected to power network should depend on the CT quantity. For 2pcs of CT, it should be 3 phase 3 wire connection. For 3pcs of CT, it should be 3 phase 4 wire connection.
- Please pay high attention on the difference between 3 phase 3 wire and 3 phase 4 wire connection, because wrong connection may lead to incorrect calculation of power factor, power and energy.

## Panel Indication



No.	symbol	Name	Function
1		Set Key	In measure interface, energy, harmonics, tariff rate, record, event interface, used to back to guide page. In setting interface, select the menu or parameter need to be modified, and press Set key to make confirmation after finishing modification.
2		Left Key	move cursor to left: in parameter modifying interface, used to select the menu and modified parameter. page down: in running interface, used to turn to back page.
3		Right Key	move cursor to right: in parameter modifying interface, used to select the menu and modified parameter. page up: in running interface, used to turn to front page.
4		Decrease Key	parameter modification: used to decrease value in parameter modification interface.
5		Increase Key	parameter modification: used to increase value in parameter modification interface.
6		Return Key	In menu operation, it is used to return to previous menu

In initial status, meter will come to guide page after power on . There are instantaneous parameters, energy, harmonics measurement, tariff rate kwh, energy record, event record and meter setting and display setting in guide pages ..

Press **<<** **>>** **↑** **↓** to move cursor . Press **SET** to enter subpages accordingly.

In electrical , energy, harmonic, tariff, record and event page, press **SET** to back to guide page.

In meter set and display set interface , press **ESC** to guide page interface.

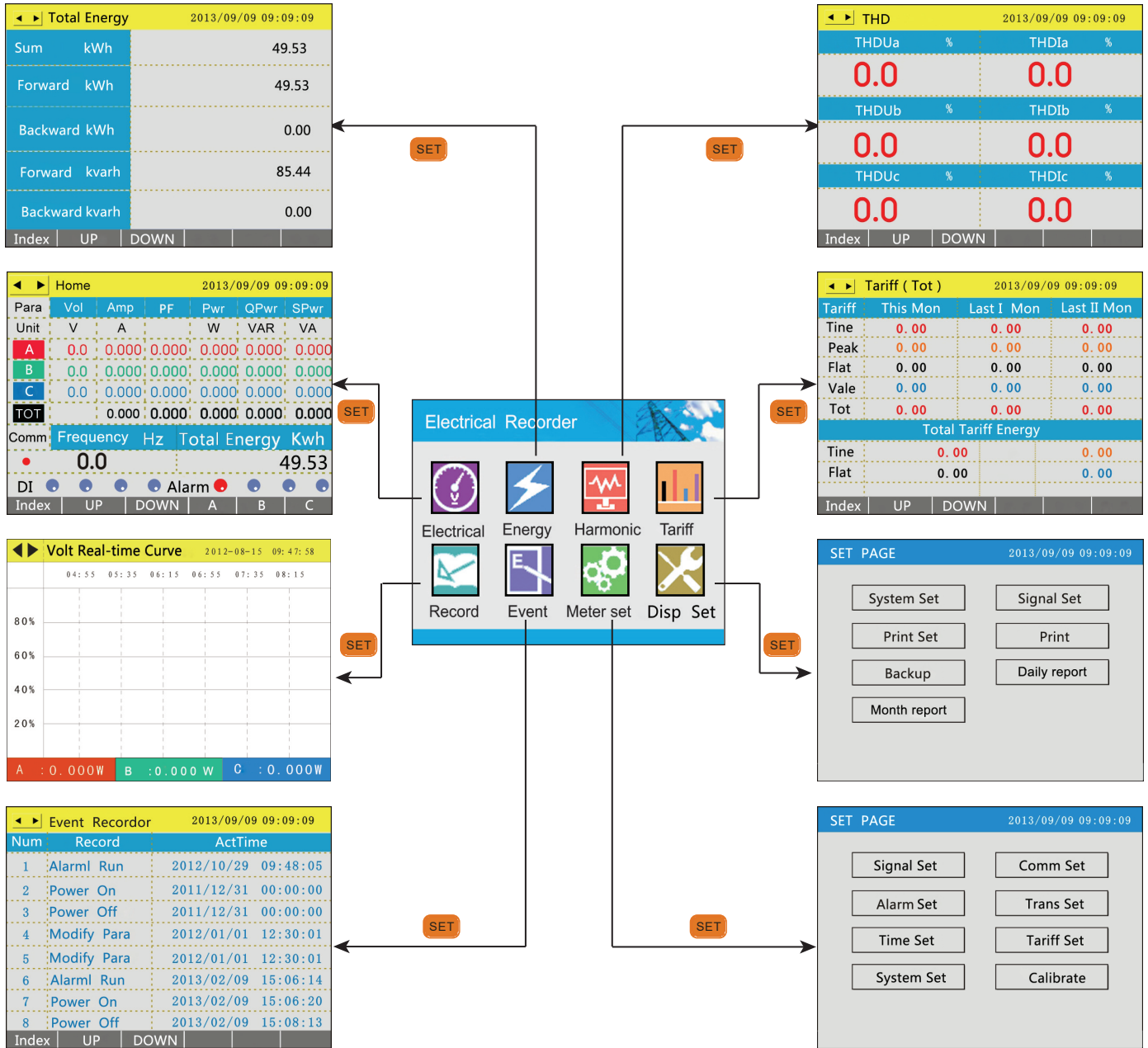

## Instant Electric Parameters Page Operation Process

In "electrical" interface, press **<<** **>>** key to shift the page. In any pages, press **SET** to back to guide page.

In the bottom of display interface, there is press key operation remind

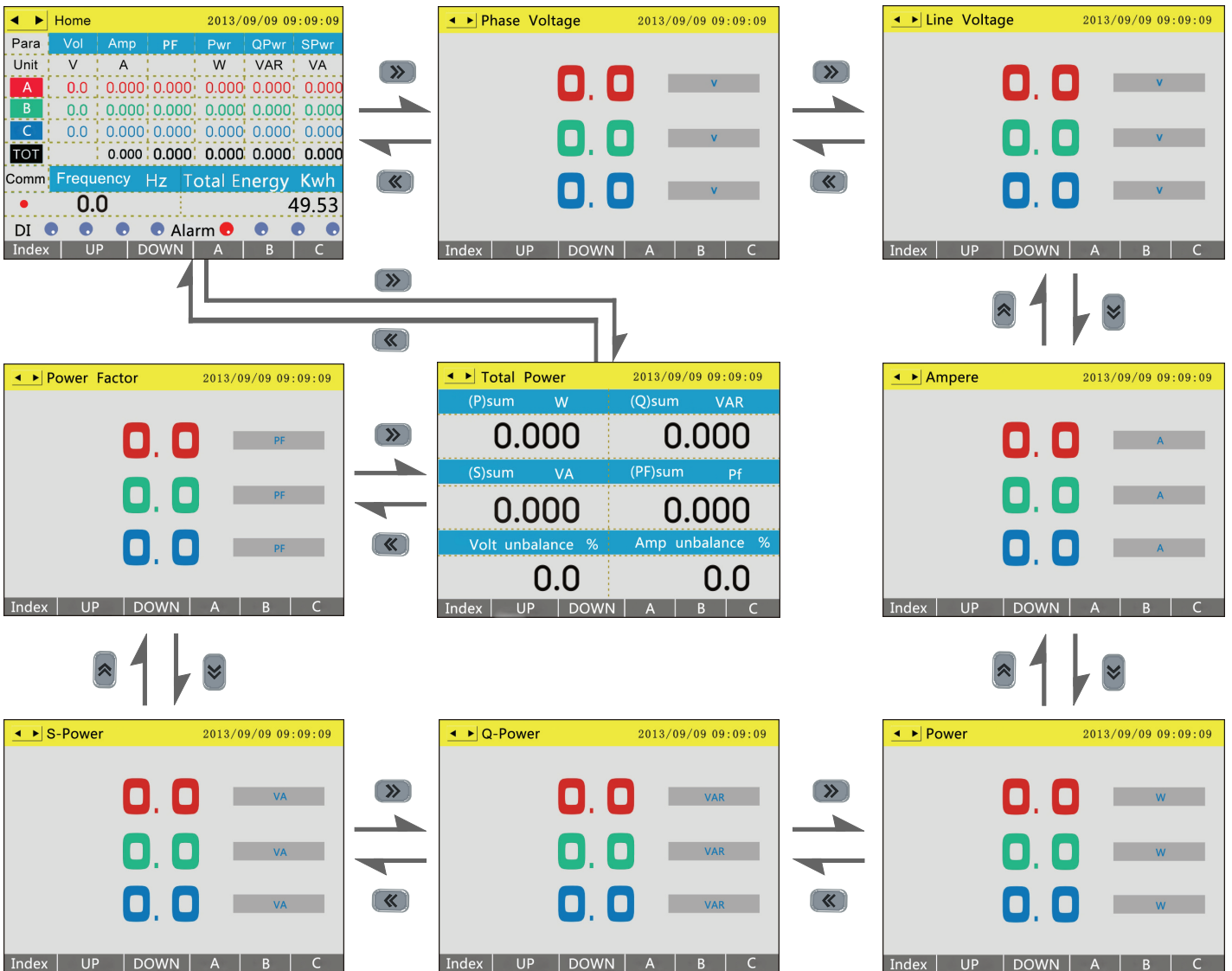

## Energy Interface Operation

In "energy" interface, press **<<** **>>** key to shift the page. In any pages, press **SET** to back to guide page.

In the bottom of display interface, there is press key operation remind

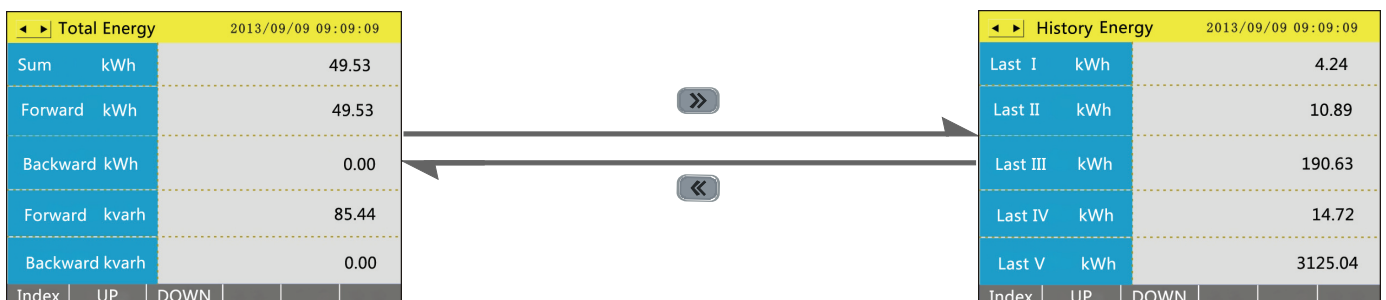

## Harmonic Page Operation

THD			
2013/09/09 09:09:09			
THDUa	%	THDIa	%
0.0		0.0	
THDUb	%	THDIb	%
0.0		0.0	
THDUc	%	THDIc	%
0.0		0.0	

In "electrical" interface , press key to shift the page.

In any page , press to back to guide page.

In the bottom of display interface , there is press key operation remind

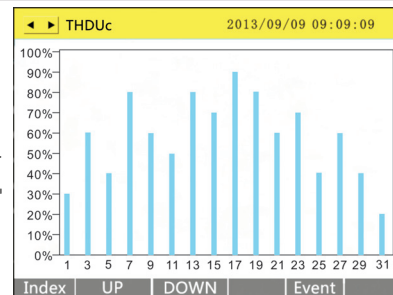
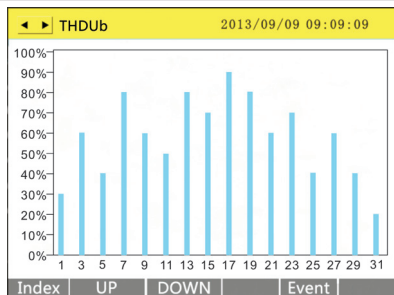
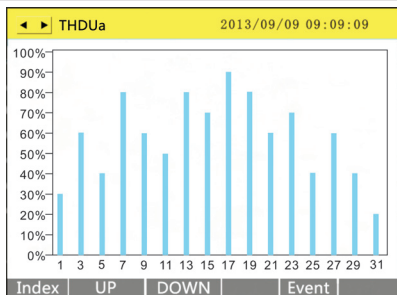

Note: This function is not available now

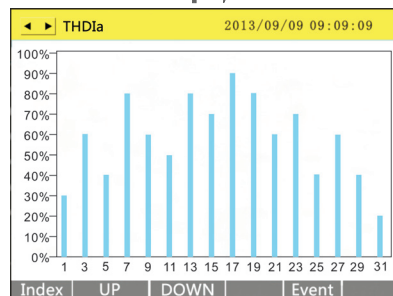
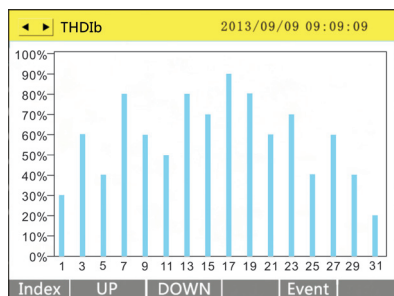
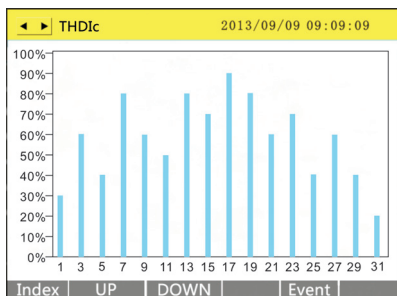

## Tariff Rate Operation

In "tariff " interface , press key to shift the page. In any pages , press to back to guide page.

In the bottom of display interface , there is press key operation remind

Tariff (Total)			
2013/09/09 09:09:09			
Tariff	This Mon	Last I Mon	Last II Mon
Tine	0.00	0.00	0.00
Peak	0.00	0.00	0.00
Flat	0.00	0.00	0.00
Vale	0.00	0.00	0.00
Total	0.00	0.00	0.00
Total Tariff Energy			
Tine	0.00		0.00
Flat	0.00		0.00

Tariff ( This M )		
2013/09/09 09:09:09		
Tine kWh		0.00
Peak kWh		0.00
Plane kWh		0.00
Vale kWh		0.00
Total kWh		0.00

Tariff ( Last I M )		
2013/09/09 09:09:09		
Tine kWh		0.00
Peak kWh		0.00
Plane kWh		0.00
Vale kWh		0.00
Total kWh		0.00



Demand			
2013/09/09 09:09:09			
Mode	Record	ActTime	
PDMD	0.000 W	2012/10/29 09:48:05	
PDMDMX	16.50 KW	2011/12/31 00:00:00	
QDMD	0.000 VAR	2011/12/31 00:00:00	
QDMDMX	28.45 KAVR	2012/01/01 12:30:01	

Tariff ( Last II M )		
2013/09/09 09:09:09		
Tine kWh		0.00
Peak kWh		0.00
Plane kWh		0.00
Vale kWh		0.00
Total kWh		0.00

## Record Interface Operation



## Event Record Process

In "electrical" interface, press **◀** **▶** key to shift the page. In any pages, press **SET** to back to guide page.

In the bottom of display interface, there is press key operation remind

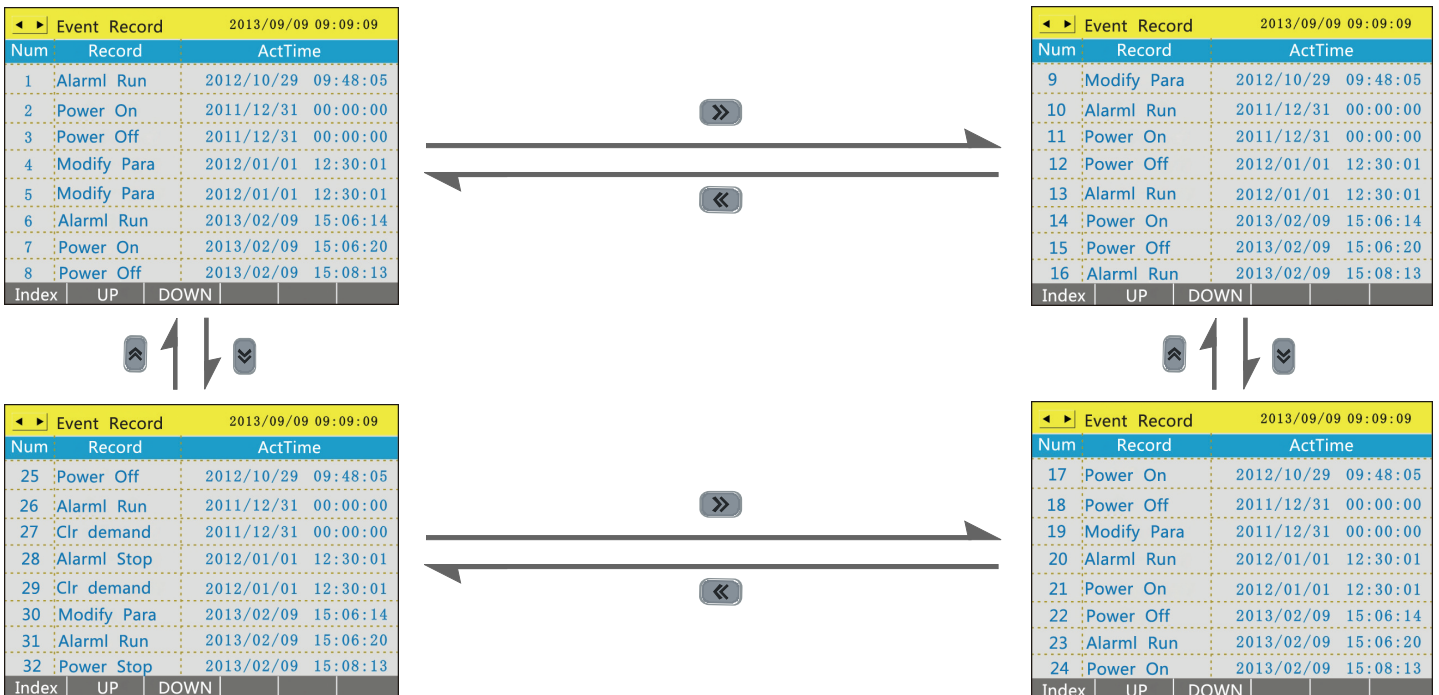

## Meter Parameter Set Operation Process

Submenu operation in configuration setting interface

In measuring status , press **SET** to enter into code password interface. Press **◀ / ▶** to move to password cursor , press **▲ / ▼** to input password , press **SET** to confirm to enter configuration set interface.

In the interface , press **◀** or **▶** to choose submenu to be operated. When the corresponding setting frame show blue background , press **SET** to enter operation menu. In operation interface , press **◀** or **▶** to choose the data frame to be modified. When it is blue or black background , press **▲ / ▼** to modify value or press **SET** to show data input dialog box . In dialog box , press **◀** or **▶** to select to delete, cancel or modify operation. After finishing value modification , press **ESC** to return the operating menu. Press **ESC** to confirm and exit the interface . It will appear whether save the dialog box , select yes to storage the value and exit.

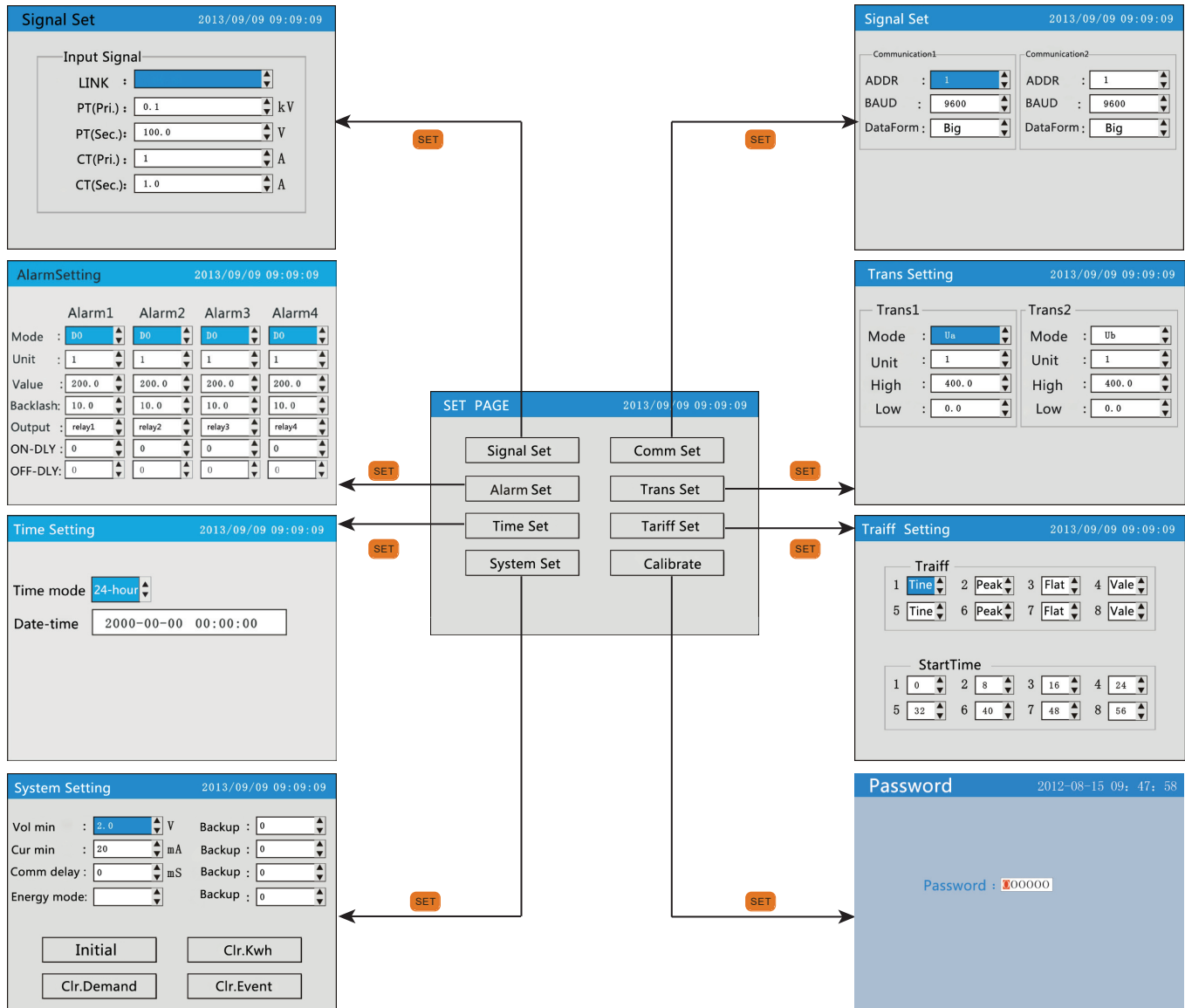

No.	class 1	class 2	description	range
1	Signal set	Link	Select the input network of the measured signal	3-3/3-4
		PT (Pri)	Primary coil voltage , unit kV	0~999.9
		PT (Sec)	Secondary coil voltage , unit V	10~999.9
		CT (Pri)	Primary coil current , unit A	0~9999
		CT (Sec)	Secondary coil current , unit A	0~999.9
2	communication 1	Address	meter address range	1~247
		baud rate	Baud rate	1200/2400/4800/9600/19200
		Data sequence	Data sequence: high digit in front or low digit in front	0/1
	communication 2 (can be ordered)	Address	meter address range	1~247
		baud rate	Baud rate	1200/2400/4800/9600/19200
		Data sequence	Data sequence: high digit in front or low digit in front	0/1



3	Alarm Set	Alarm 1	mode	When value is 0 , it is for remote control mode, otherwise it is for alarm mode. Please refer to table 1.	0~68	
			unit	1: international standard unit, K: 1000 times standard unit, M: means1000000 times standard unit.	0~2	
			value	1st alarm value setting	0~999.9	
			backlash	1st alarm hysteresis value setting	0~999.9	
			output	1st alarm relay output setting	0~1	
			ON-DLY	alarm start delay time , unit : second	0~99	
			OFF-DLY	alarm finish delay time , unit : second	0~99	
		Alarm 4		⋮		
			mode	When value is 0 , it is for remote control mode, otherwise it is for alarm mode. Please refer to table 1.	0~68	
			unit	1: international standard unit, K: 1000 times standard unit, M: means1000000 times standard unit.	0~2	
			value	4th alarm value setting	0~999.9	
			backlash	4th alarm hysteresis value setting	0~999.9	
			output	4th alarm relay output setting	0~1	
			ON-DLY	alarm start delay time , unit : second	0~99	
OFF-DLY	alarm finish delay time , unit : second	0~99				
4	Trans Set	Trans 1	Mode	Please refer to table 1	1~32	
			Unit	1: international standard unit, K: 1000 times standard unit, M: means1000000 times standard unit.	1/K/M	
			High	Transmit output 20mA	0~999.9	
			Low	Transmit output 4mA	0~999.9	
	Trans 2 can be ordered	Mode	Please refer to table 1	1~32		
		Unit	1: international standard unit, K: 1000 times standard unit, M: means1000000 times standard unit.	1/K/M		
		High	Transmit output 20mA	0~999.9		
		Low	Transmit output 4mA	0~999.9		
5	Time set	time mode	24 hours	select 12/24		
		Date-time	year month day hour minute second	set correct time		
6	Tariff Setting	tariff	1	Period 1 tariff means tine tariff, Peak tariff, flat tariff, vale tariff	0~3	
			2	Period 2 tariff means tine tariff, Peak tariff, flat tariff, vale tariff	0~3	
			3	Period 3 tariff means tine tariff, Peak tariff, flat tariff, vale tariff	0~3	
			⋮			
		7	Period 7 tariff means tine tariff, Peak tariff, flat tariff, vale tariff	0~3		
		8	Period 8 tariff means tine tariff, Peak tariff, flat tariff, vale tariff	0~3		
		start time	1	Period 1 start time	0~95	
			2	Period 2 start time	0~95	
			3	Period 3 start time	0~95	
			⋮			
7	Period 7 start time		0~95			
8	Period 8 start time		0~95			
7	System Set	Volt min	set minimum value of voltage	0~999.9		
		Cur. Min	set minimum value of current	0~999.9		
		Comm. delay	set communication delay , unit:ms	0~10		
		Energy Mode	energy calculation mode . 1 means primary calculation. 2 means secondary calculation	0~1		
		Extend 1	for spare			
		Extend 2	for spare			
		Extend 3	for spare			
		Extend 4	for spare			
		Initial	reset to factory default setting			
		Clr. Kwh	clear kwh			
		Clr. Demand	clear demand			
Clr. Event	clear event					
8	calibrate	password	factory setting , not opened			

**Note** Divide 24 hours a day into 96 segments, every 15 minutes as one segments. For example, the corresponding time for segment 0 is 0 o'clock, the corresponding time for segment 10 is 2:30. Please notice that, the setting of period 1 to period 12 should be from small to big.

Reference table 1: Reference table for alarm output and transmit output

No.	Parameter	switch output code low alarm	switch output code high alarm	transmit output code 4-20mA
1	Ua (A phase voltage)	1 (UaL)	2 (UaH)	1 (Ua)
2	Ub (B phase voltage)	3 (UbL)	4 (UbH)	2 (Ub)
3	Uc (C phase voltage)	5 (UcL)	6 (UcH)	3 (Uc)
4	U (phase voltage of A, B or C)	7 (UL)	8 (UH)	4 (U)
5	Uab (AB line voltage)	9 (UabL)	10 (UabH)	5 (Uab)
6	Ubc (BC line voltage)	11 (UbcL)	12 (UbcH)	6 (Ubc)
7	Uca (CA line voltage)	13 (UcaL)	14 (UcaH)	7 (Uca)
8	UL (line voltage of AB, BC or CA)	15 (ULL)	16 (ULH)	8 (UL)
9	Ia (A phase current)	17 (IaL)	18 (IaH)	9 (Ia)
10	Ib (B phase current)	19 (IbL)	20 (IbH)	10 (Ib)
11	Ic (C phase current)	21 (IcL)	22 (IcH)	11 (Ic)
12	I (A, B or C phase current)	23 (IL)	24 (IH)	12 (I)
13	Pa (A phase active power )	25 (PaL)	26 (PaH)	13 (Pa)
14	Pb ( B phase active power )	27 (PbL)	28 (PbH)	14 (Pb)
15	Pc ( C phase active power )	29 (PcL)	30 (PcH)	15 (Pc)
16	Ps ( total active power )	31 (PL)	32 (PH)	16 (P)
17	Qa( A phase reactive power)	33 (QaL)	34 (QaH)	17 (Qa)
18	Qb( B phase reactive power)	35 (QbL)	36 (QbH)	18 (Qb)
19	Qc( C phase reactive power)	37 (QcL)	38 (QcH)	19 (Qc)
20	Qs ( total reactive power )	39 (QL)	40 (QH)	20 (Q)
21	Sa ( A phase apparent power )	41 (SaL)	42 (SaH)	21 (Sa)
22	Sb ( B phase apparent power )	43 (SbL)	44 (SbH)	22 (Sb)
23	Sc ( C phase apparent power )	45 (ScL)	46 (ScH)	23 (Sc)
24	Ss ( Total apparent power)	47 (SL)	48 (SH)	24 (S)
25	PFa (A phase power factor)	49 (PFaL)	50 (PFaH)	25 (PFa)
26	PFb( B phase power factor)	51 (PFbL)	52 (PFbH)	26 (PFb)
27	PFc( C phase power factor)	53 (PFcL)	54 (PFcH)	27 (PFc)
28	PFs (Total power factor)	55 (PFLl)	56 (PFLH)	28 (PFL)
29	Frequency	57 (FL)	58 (FH)	29 (F)
30	EP (total kwh)	59 (EPL)	60 (EPH)	30 (EP)
31	EQ (total kvarh)	61 (EQL)	62 (EQH)	31 (EQ)
32	netural line current	63 (InL)	64 (InH)	32 (In)
33	unbalance	65 (UNNB)	66 (ULNB)	
34	unbalance	67 (INNB)	68 (PNNB)	

Note: ① The above alarm setting values are positive number without symbol , not support negative value setting.

② Power factor only support one decimal point.

③ Alarm delay unit is second.

## Record Backup Operation Process

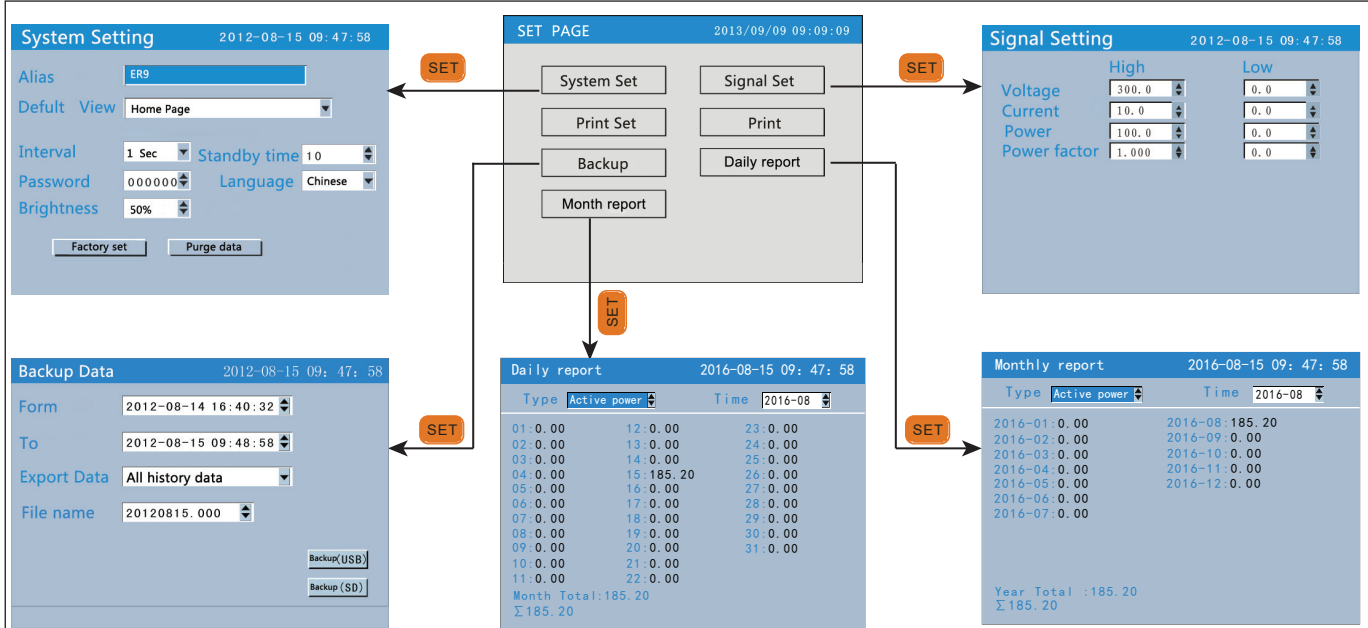

## Data Backup Operation

### 1. Data Backup Page Operation

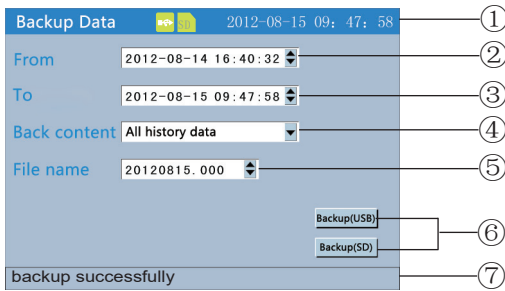

1. Status bar shows interface name , USB & SD card connection status
2. From : Data backup start time
3. To : Data backup end time
4. Backup content : include all history data record , alarm record , accumulated daily report form , monthly report form .
5. Backup file name : present data + file serial number.
6. Backup the file to USB or SD card
7. Backup progress bar and backup status display.

### Backup by manual

1. Confirm USB or SD card connect well with power recorder , check the SD card or USB status remind on the status bar.
2. Set backup data start time
3. Set backup data finish time
4. Set the backup file content .
5. Confirm the file name , file name format , data and serial number.
6. Move cursor to backup USB / SD card , and press **SET** to confirm backup.
7. Press **ESC** key to return function list interface after finishing backup.

### Auto-Backup

1. When insert the SD card to power recorder, and it reminds that the status is normal , then the recorder will backup the data to the SD card automatically at 0:00 and 12:00 every day.
2. During backup , it will appear a blue progress bar , after finishing backup , the progress bar will disappear. If backup failed or SD card is full , it will keep displaying red progress bar.

### backup illustration:

1. please use formated SD or USB , use FAT32 version.
2. please use PC to format SD card or USB.
3. USB port: support USB2.0 protocol , maximum capacity is 4GB.
4. SD card port: standard SD card , maximum capacity is 4GB.

## Configuration Setting Menu Function

No.	Menu	Submenu	Description
1	System set	Alias	Can modify the name of the meter , ex-factory setting is Ammeter
		Default view	Main display interface , integrated parameters is default screen
		Interval	record time interval, default is 1second
		Standby time	screen display rest delay time , when set as 0 , no display rest delay function , default value is 10minutes
		Password	Password modification . The password can be modified , ex-factory setting is 000000
		System language	Chinese and English can be shift
		Factory set	Recorder will return all parameters to factory setting when confirm this function.
		Purge data	Clear all the record data
		Purge accu	Clear accumulated power energy to zero
2	Signal set	voltage curve high/ low limit	Input voltage high limit and low limit , default setting is 300 and 0
		current curve high/ low limit	Input current high and low limit , default setting is 10 and 0
		power curve high / low limit	Each phase power high and low limit , default setting is 100 and 0
		power factor curve high / low limit	Each phase power factor low and high limit , default setting is 1 and 0
3	backup	From	Data backup start time
		to	Data backup end time
		Export data	select the export data
		Backup file name	Backup file name
		backup to USB	backup to USB
		backup to SD	backup to SD
4	daily report	record kwh everyday	record kwh everyday
5	monthly report	record kwh every month	record kwh every month

### ■ Modify setting Item

#### Input Panel

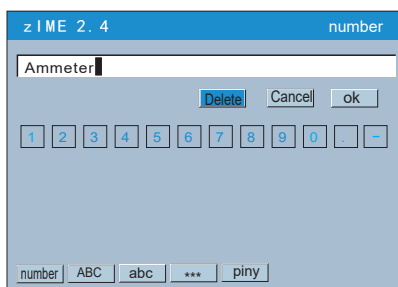

Input Panel Operation:

- ⬅ / ➡ : Move the soft keyboard cursor ( include function , input type , PinYin or character choice)
- ⬆ / ⬇ : When cursor is in Pinyin, can switch the Pinyin and character.
- SET : When cursor is in 123 , ABC , abc , \*\*\* , input the letter in the cursor position into display column.

There are three type modification: adjust input parameter,edit input parameter,select input parameter

1. Adjust input parameter

Using ⬆ and ⬇ to adjust the content which cursor is on.

2. Edit input parameter

If edit data , press ⬆ and ⬇ to adjust the parameter , press SET to popup input panel . User can input data、 capital letter、 small letter、 symbols 、 characters by input panel.

3. Select input parameter

Press ⬆ / ⬇ and SET to popup select list , press ⬆ / ⬇ to move and select cursor, press SET to confirm content. Press ESC to cancel the selection .

Move cursor to the parameters to be modified , press SET to popup input panel, user can operate input by input panel.

Warning: must input the name to square frame ,cannot be empty. Not support chinese characters

Delete : delet the last letter in input column

Cancel: exit input panel, cancel editing.

OK : exit form input panel , and confirm the editing.  
If cursor is the position of input type item , press ok to confirm the input type.

## ■ Curve Record Operation

### 1. realtime curve display operation show

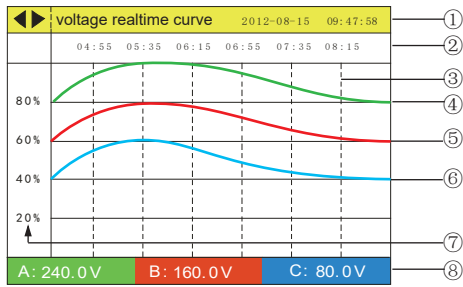

### 2. history curve record operation show

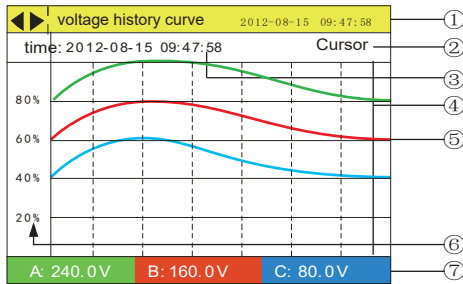

#### 1. Status bar display

Display interface name , data and time

◀ ▶ : means use ◀◀ or ▶▶ key to shift the display interface.

#### 2: real time of the record

3. grid : easy for check record curve in each grid or layout

4. A phase real time record curve , the color is the same with A phase measuring data

5. B phase real time record curve , the color is the same with B phase measuring data.

6. C phase real time record curve , the color is the same with C phase measuring data

7: curve display percentage scale

8: present interface curve corresponding measure value.

#### 1. Display history record interface name , data and time

2. Data recall mode : recall mode and cursor mode . Press **SET** to shift the mode.

3. Recall time : present cursor corresponding time .

4. Recall bar : convenient for user to locate time and data . In cursor mode , press ▲ / ▼ to move location to left and right.

5. Data history curve , display 3 phase data by three different curve

6. Scale : curve display percentage scale

7. 3 phase history data : Display the history data of recall bar located position.

## ■ Standard Software Usage Brief

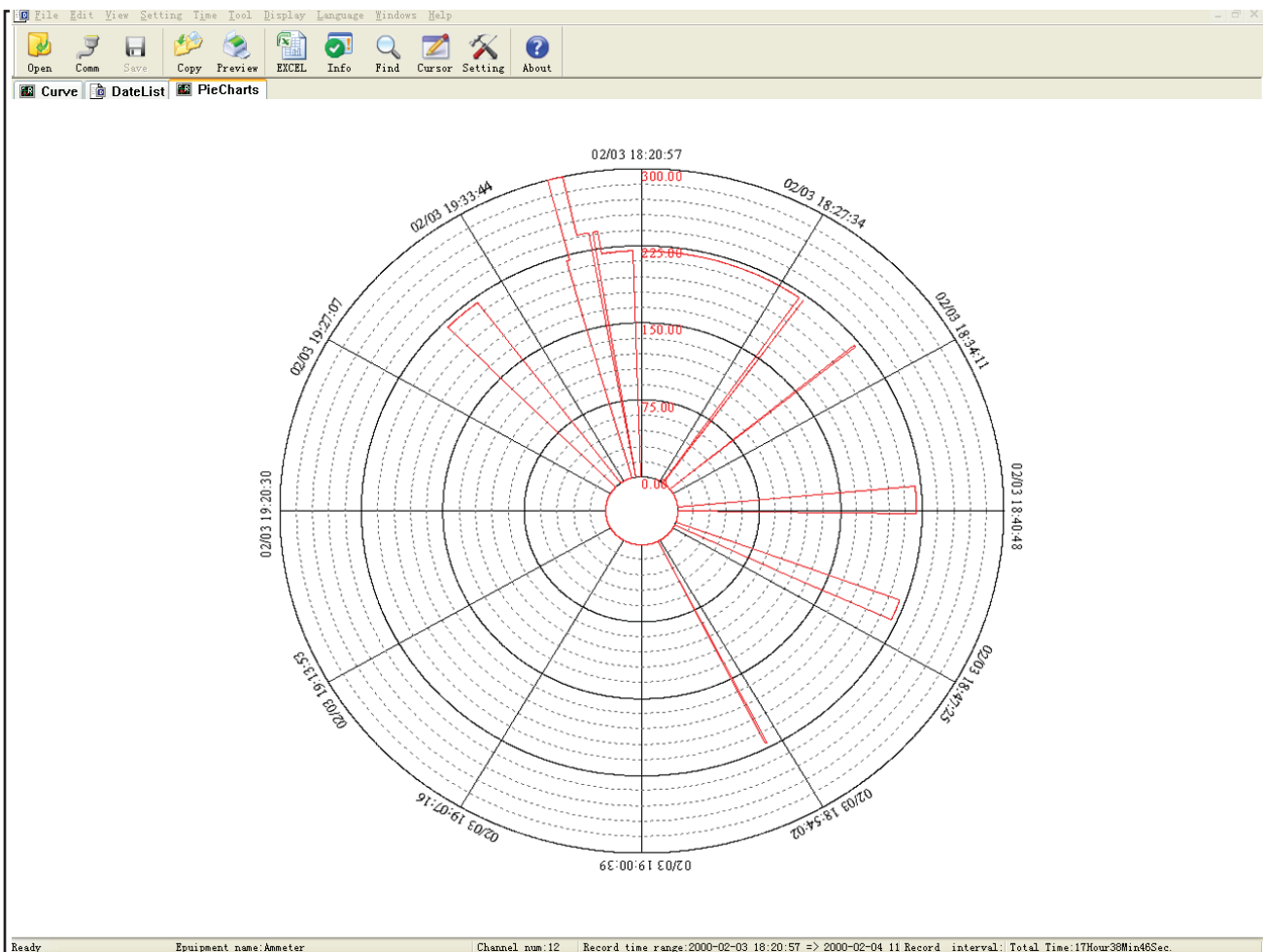

## PC Software Function

1. Used to open and check the data in SD card or USB , files version type is date.EDZ or Date.files series number
2. Make history data analysis by history curve , data list, circle diagram display.
3. Export excel data.
4. Preview print history curve,data list , circle diagram.
5. Make history data statistics by statistics functions in tools menu.
6. Language menu set Chinese or English display.
7. In history curve display interface , make history curve analysis in section by editing add tag , tag management, curve hidden function.

## ■ Output Function

### 1. Energy pulse

DR9 provides the function of energy calculation, with 2 energy pluse output AP & RP, and RS485 interface for the transmit of energy data. The energy pulse of optical couple relay with open collector enables the long distance transmit of active energy AP & reactive energy RP. Remote PC terminal, PLC, DI On-Off output and collector module are applied to collect the pulse of energy meter to enable the energy cumulation calculation. Besides, this output mode is also the energy accuracy check way (National metrology regulations: Standard meter pulse tolerance comparison method)

(1). Electrical characteristic: the output of optical couple relay with open collector ,  $V \leq 48V$ ,  $I_z \leq 50mA$

(2). Pulse constant: 9000imp/kwh. It means the impulse output No. is 9000 when the energy meter counts up to 1KWH.

The piont should be emphasized is that the above 1kwh is for the 2nd coil energy. Supposed that PT and CT is connected , the primary coil energy that 9000 pulse refer to is equal to  $1kwh \times \text{voltage transform PT} \times \text{current transform CT}$ .

2. Remote measure and remote control function: 4 loops S1-S4 are used to remote measure electric ON/OFF status. DO1 & DO2 function can be used to remote control electric devices. When using Do function, alarm mode should be setted as 0, otherwise DO1 and DO2 will be as AL1, AL2 output. DO1 DO2 function control value is written via RS485 interface.
3. Communication function ( please refer to the communication protocol)
4. Transform output( please refer to table 1)
5. Alarm function (please refer to table 1)
6. Data record report output , backup the data to SD card or USB . We offer software to make analysis the data on PC.