

Intelligent Temperature Controller User Manual



Features

- Optional input signal types.
- PID arithmetic and with auto-tuning function.
- Different control types (please refer OT parameters).
- RUN/STOP function can be switch.

The instruction explain instrument settings, connections,name and etc,please read carefully before you use the temperature controller.

Model Illustration

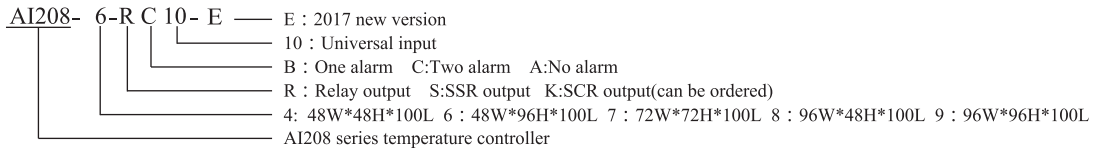

NOTE:If you choose heating and cooling control type and also need alarm function,please choose two alarm.

Order Information

No.	Model	Control	Alarm
1	AI208-4/6/7/8/9-SC10	SSR	2
2	AI208-4/6/7/8/9-SB10	SSR	1
3	AI208-4/6/7/8/9-RC10	RELAY	2
4	AI208-4/6/7/8/9-RB10	RELAY	1

1.Electrical parameters :

Sample rate	2 times/per second
Relay capacity	AC 250V /3A life of rated load>100,00 times
Power supply	AC/DC 100 ~ 240V(85-265V)
Power consumption	< 6VA
Environment	Temperature of indoor:0 ~ 50°C no condensatng; Humidity : < 85%RH,altitude<2000m
Storage environment	-10 ~ 60°C,no condensatng
SSR output	DC 24V pulse voltage,load<30mA
Insulation impednce	input,output,power VS meter cover > 20MΩ
ESD	IEC/EN61000-4-2 Contact ±4KV /Air ±8KV perf.Criteria B
Pulse traip anti-interference	IEC/EN61000-4-4 ±2KV perf.Criteria B
Surge immunity	IEC/EN61000-4-5 ±2KV perf.Criteria B
Voltage frop & Shortinterruption immunity	IEC/EN61000-4-29 0% ~ 70% perf.Criteria B
Dielectric strength	Signal input & output & power 1500VAC 1min,below 60V low voltage DC500V,1min
Total weight	About 400g
Shell material	The shell and panel framePC/ABS (Flame class UL94V-0)
panel material	PET(F150/F200)
Power failure memory	10years,times of writing:1 million times
Panel protection level	IP65(IEC60529)
Safety standard	IEC61010-1 overvoltage categoryII,pollution level 2,levelIII(Enhanced insulation)

2.Isolation diagram:

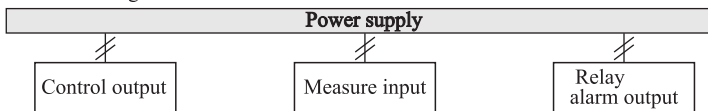

“//” : Isolation

3.Measured signal specification:

Input type	symbol	Measuring range	Resolution	Accuracy	input impedance/ auxiliary current
K	℄	-50 ~ 999	1°C	0.5%F.S±3digits	> 500kΩ
J	℄	0 ~ 999	1°C	0.5%F.S±3digits	> 500kΩ
E	℄	0 ~ 850	1°C	0.5%F.S±3digits	> 500kΩ
T	℄	-50 ~ 400	1°C	0.5%F.S±2°C	> 500kΩ
PT100	℄℄	-200 ~ 600	1°C	0.5%F.S±3digits	0.2mA
CU50	℄℄S	-50 ~ 150	1°C	0.5%F.S±3°C	0.2mA
CU100	℄℄B	-50 ~ 150	1°C	0.5%F.S±1°C	0.2mA

■ Name of universal panel

No	Symbol	Name	Function
1	OUT1	OUT1 light(red)	Host control output indicator light,it light when the output is 0N
	OUT2	OUT2 light(red)	Cooling output indicator light,it light when the output is 0N
	AL1	Alarm1# light(red)	1st loop alarm output indicator light,alarm output with light,no alarm output without light.
	AL2	Alarm2# light(red)	2nd loop alarm output indicator light,alarm output with light,no alarm output without light.
	AT	AT light(green)	Auto-tuning indicator light,it show setting state when it light
2	SET	SET function key	Menu key/ensure key,to use enter or back to modified mode or ensure/save parameters
3	←AT	Shift/AT key	Activation key/shift key/AT setting key,long press to enter or back to auto-tuning under the measure control mode.
4	↕	Add key/R/S	Add key,long press it can reach switch of RUN/STOP mode under the measure control mode.
5	⇓	Reduce key	Reduce key
6	SV	Display window(green)	Setting value/parameters display window,display "STP" =stop control
7	PV	Display window(red)	measured value/parameters code display window

■ Dimension and installation size

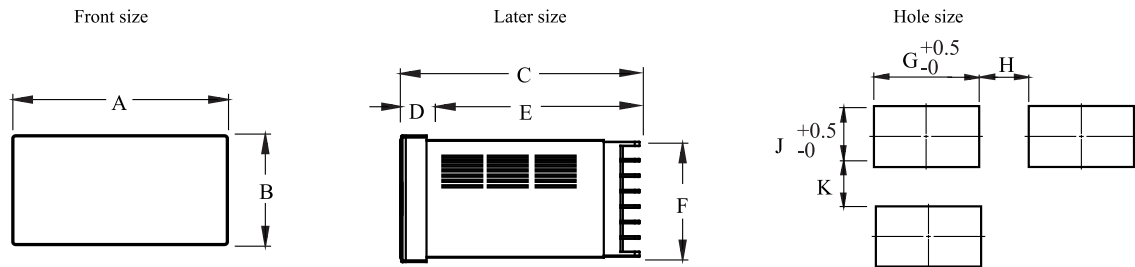

Model	A	B	C	D	E	F	G	H(Min)	J	K(Min)
4:(48*48)	48	48	97.5	6.5	91	45	45.5	25	45.5	25
6:(96*48)	48	96	97.5	9	88.5	89.5	45	25	92	25
7:(72*72)	72	72	97.5	9	88.5	67	67.5	25	67.5	25
8:(48*96)	96	48	97.5	9	88.5	44.5	92	25	45	25
9:(96*96)	96	96	97.5	9	88.5	91.5	92	25	92	25
80:(80*160)	160	80	96	13	83	75.5	155.5	30	76	30
16:(160*80)	80	160	96	13	83	155	76	30	155.5	30

■ Operation & Menu

1. Operation process of Factory default (PID heating):
Measure control mode

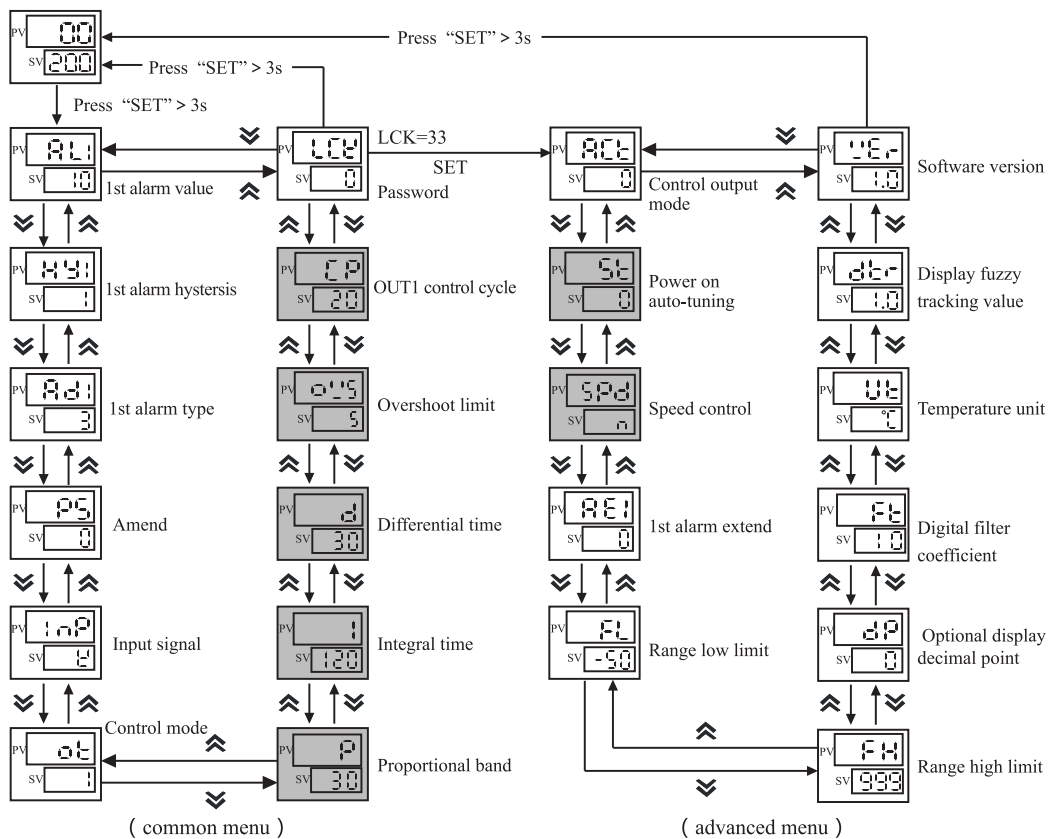

NOTE: The meter will hide unrelated parameters according to operation way of OT parameter. We suggest to set the OT parameters before using the meter in the first time.

 Parameters will keep display all the time for all the model and all the setting.

 Parameters will be hidied based on model and menu setting.

2.Menu Illustration



No.	Symbol	Name	Description	Set range	Factory default
1	AL1	AL1	1st alarm value,note:the minus is dealed as absolute value when it is as a deviation value .	FL ~ FH	10
2	HY1	HY1	1st alarm backlash value	0 ~ 100	1
3	AD1	AD1	1st alarm value,note:the minus is dealed as absolute value when it is as a deviation value.Set AD2 to 0 when actting value >6.Otherwise it will close alarm function when it is 0.	0 ~ 12	3
4	AL2	AL2	Set AD2 to 0 when actting value>6.Otherwise it will close alarm function when it is 0.	FL ~ FH	5
5	HY2	HY2	2nd loop alarm backlash value	0 ~ 100	1
6	AD2	AD2	2nd loop alarm type,note:the value should set 0 to close alarm function when the AD1>6.	0 ~ 6	4
7	PS	PS	Translation correction value,display value=actual measured value+translation correction value	-199 ~ 999	0
8	INP	INP	Optional input measured signal type:refer to input signal parameters table. Note:it need to change the relevant parameters after changing.	K ~ CU100	K
9	OT	OT	Control type: 0 : ON/OFF control , related parameter: DB ; 1 : PID heating,related parameters:P,I,D,OVS,CP,ST,SPD ; 2 : Compressor cooling,related parameters:DB,PT ; 3 : PID heating & cooling(Cooling control OUT2 output by AL1 relay),related parameters:P,I,D,OVS,DB,CP,CPI,PC,ST,SPD ; 4 : Excess temperature cooling control type,related parameter:DB	0 ~ 4	1
10	P	P	Proportional band,the lower of setting value,the faster of system heating or the more slowly.Increasing proportional band can reduce vibration,but it will add the control bias vibration.Reducing proportional band can reduce control bias,but it will lead to vibration	0 ~ 999	30
11	I	I	The lower of integral time value,the stronger of integral action,the more tendency to eliminate and deviation of a set value. If integral action is week,it maybe can not eliminate the deviation. Unit:S	0 ~ 999	120
12	D	D	Differential time,reduce the effect of differential time to a proper value,which can prevent the system oscillation.The higher value,the stronger function of differential.Units	0 ~ 999	30
13	OVS	OVS	Overshoot limit,in the process of PID control,when PV>SV+OVS,it force off output;The lower value,the lower PID adjusted range,the worse control stability;please set a proper value according actual state.	0 ~ 999	5
14	DB	DB	Bit control backlash(negative backlash bit control)or cooling control and compressor cooling control dead zone. please change the value according to decimal position,when you change INP type.	0 ~ 100	5
15	CP	CP	OUT1 control cycle,1:SSR control output,4-200:relay control output.Units	1 ~ 200	20
16	CP1	CP1	OUT2 control cycle,cooling relay output cycle.Units	4 ~ 200	20
17	PC	PC	OUT2 cooling proportionality coefficient,the higher of value,the stronger of cooling	1 ~ 100	10
18	LCK	LCK	Lock function. 001:SV value can not be modified;010:menu setting value only can be checked ,cannot modified; 033: canenter to advanced menu; 123: menus reset to factory setting.	0 ~ 999	0

3.Advanced Menu Illustration

19	ACT	ACT	Control execution type,0:relay/SSR output;1:single SSR output control	0 ~ 1	0
20	ST	ST	power on auto-tuning switch . 0: normal control after power on 1: enter PID auto-tuning status after power on . Long press <<AT key to exit the auto-tuning	0 ~ 1	0
21	SPD	SPD	PID control speed adjustment, optional 0(N)no function,1 (S) slow,2(ss)medium slow, 3 (SSS) very slow , 4 (F) fast , 5 (FF) medium fast , 6 (FFF) express	0 ~ 6	N
22	PT	PT	Starting relay time of compressor,unit:s	0 ~ 999	180
23	AE1	AE1	1st alarm extensions (refer to alarm extend function table page 6)	0 ~ 5	0
24	AE2	AE2	2nd alarm extensions (refer to alarm extend function table page 6)	0 ~ 5	0
25	FL	FL	Measure range low limit,the setting value must be less than measure range high limit	Refer to measured signal parameter table	-50
26	FH	FH	Measure range high limit,the setting value must be more than measure range low limit.	Refer to measured signal parameter table	999
27	DP	DP	Decimal point setting	0 ~ 1	0
28	FT	FT	PV filter coefficient of digital filter,the higher of value,the stronger of filter function	0~255	10
29	UT	UT	Temperature unit	°C、°F	°C
30	DTR	DTR	PV fuzzy tracking value,it can get a stable control display value in some status. Note:when the alarm setting value is equal with SV setting value after setting the DTR value,operation of alarm output is subject to actual measured value.	0.0~2.0	1.0
31	VER	VER	Display equipped with software version	can not be motified	V2.1

■ Key function operation

1. Monitoring mode operation

- Under the measure mode,press “  ” into monitoring mode;and on the SV window sisplay “STP” .Press “  ” to back.
- It can alter SV value and switch operation event displaying STP.
- Under the monitoring mode,host control output will stop output.

2. PID Parameter identification and auto-tuning operation:

- The factory default PID parameters usually does not apply to use occasion;please using auto-tuning function to get a suitable PID parameter.
- The meter will enter control output since the power input, now,you can set the monitoring mode to avoid to affect the effect of auto-tuning function,or switch off the power of control output load.No matter how to operate, it should guarantee the set value greater than the current measured value and drop the bigger the better.
- Before auto-tuning, set the proper alarm value,or remove the alarm effect to avoid the effect of alarm output.
- Set SV value.
- OT parameter set to 1 (PID control)
- Under the condition of PV value at normal room temperature,please back to monitoring mode or input the load power,and long press “ <<AT ” enter auto-tuning mode,now,AT indicator will shine.
- Auto-tuning need a period, to ensure the auto-tuning result,please don't modify parameters or power-off during auto tuning.
- When AT light is off , it will exit the auto-tuning. PID will update automatcially, and can get good control result.
- During auto-tuning, long press “<<AT ” key, measure beyond the range,display abnormally, shift to “STOP” status,power-offect will stop the auto-tuning.
- You can set a proper PID parameter with your rich experience.

3. PID heating & Cooling control operation
 - 1) Set the control mode OT to 3.
 - 2) PID heating control act on OUT1; Cooling control act on OUT2.
 - 3) Cooling control OUT2 will make output by AL1 alarm relay.
 - 4) Please set the cooling start offset to a value larger than 5, to ensure the cooling would not affect PID heating control impact.
 - 5) Please set the cooling control cycle CP1 to a proper value, and change the cooling scaling factor to a proper value.
 - 6) When PV value > SV+DB value, the cooling control start to effect; the bigger value of PV, the longer output time of OUT2

■ Alarm function diagram

1. Alarm parameters and output logic diagram

Symbol description : “☆” means alarm hysteresis , “▲” means alarm value , “△” means SV value

No.	Alarm type	Alarm output(AL1、AL2 is independent of each other)Image:the hatched section means the alarm action
1	High limit absolute value alarm	
2	Low limit absolute value alarm	
3	※High limit deviation value alarm	
4	※Low limit deviation value alarm	
5	※High/low limit deviation value alarm	
6	※High/low limit interval value alarm	
7	High/low limit absolute value alarm	
8	※ High/low limit deviation value alarm	
9	※ Alarm between high limit absolute value and low limit deviation value	
10	※Alarm between high limit deviation value and low limit absolute value	
11	High/low absolute value alarm	
12	※High/low limit deviation alarm	

※When the alarm value with deviation alarm set to a negative number, it will deal with it as an absolute value.

2. Alarm extension function table

AE1/AE2 value	Alarm handling mode when show HHH/LLL	Remark
0	The state when alarm keep HHH/LLL in previous time	As long as meet the requirement of alarm, alarm output
1	Forced alarm output	
2	Forced alarm close	Before the PV value reach the set value in the first time, the alarm does not output.
3	The state when alarm keep HHH/LLL in previous time	
4	Forced alarm output	
5	Forced alarm close	

■ Connections

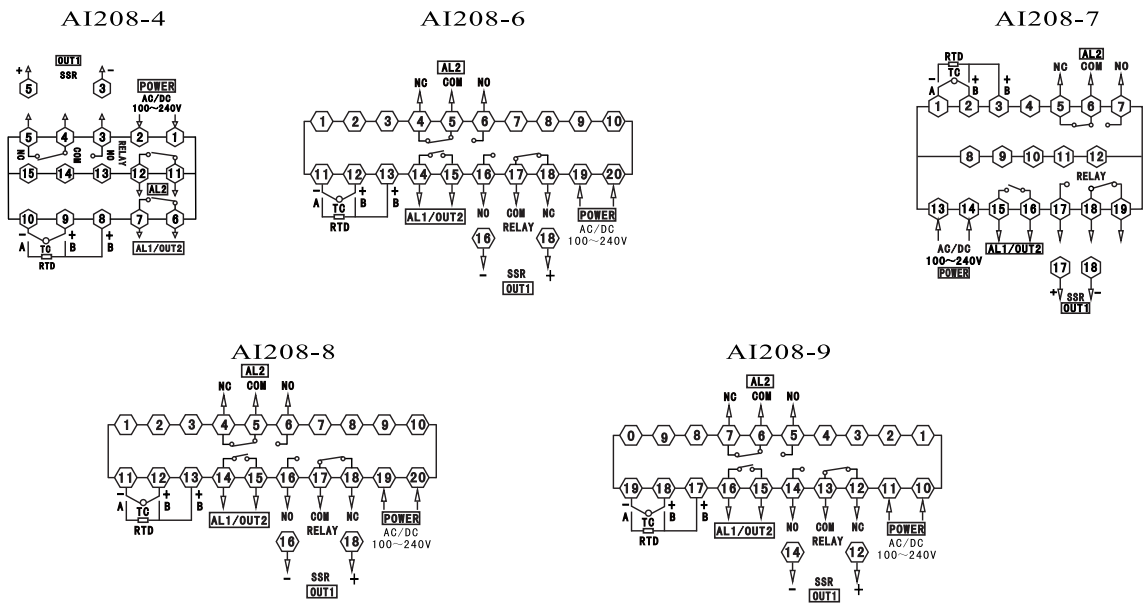

Note: If there is any change, please subject to the drawing on the meter

■ Methods of simple fault

Display	Methods
LLL/HHH	Checks whether the input disconnection and whether normal of FH value, FL value, working environment temperature and whether input signal is selected correctly.